

# OPERATING INSTRUCTIONS & SERVICE MANUAL

SOLID-STATE STEREO AMPLIFIER

## SANSUI AU-888

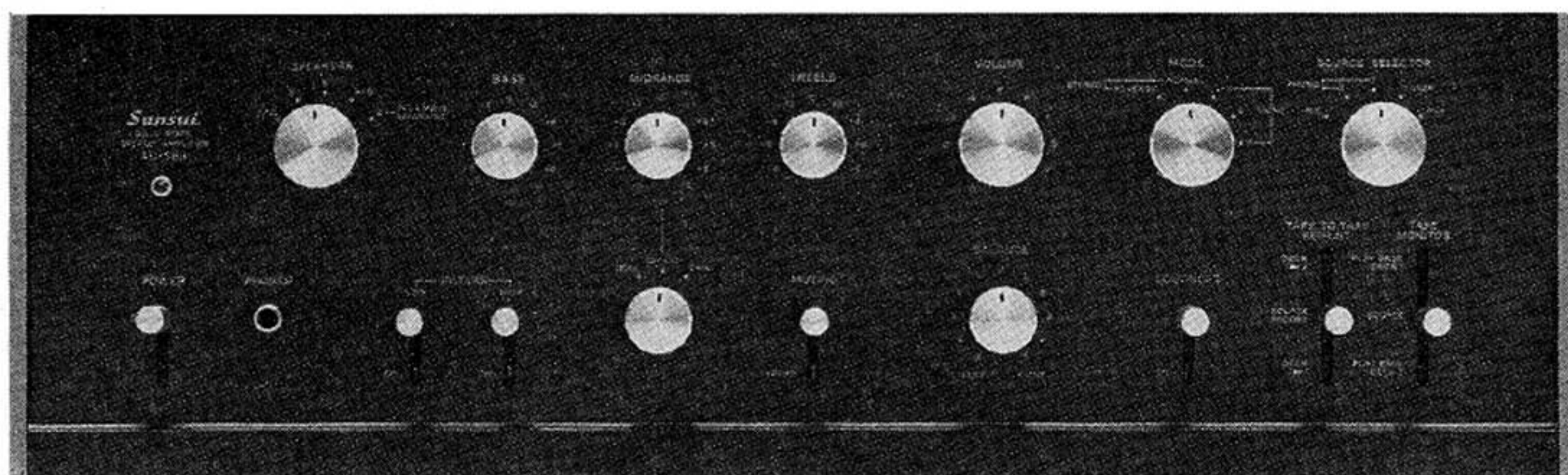

*Sansui*

SANSUI ELECTRIC COMPANY LIMITED

Congratulations on joining the thousands of proud, satisfied owners of quality stereo components from Sansui.

The AU-888 is the most advanced professional control amplifier ever manufactured by Sansui. Designed specifically for an ardent audiophile like you, it features the refined dull black panels common to all AU series professional control amplifiers from Sansui.

The preamplifier section is constructed of carefully selected low-noise PNP silicon transistors, while the power amplifier section features direct-coupled circuits specially developed with the improvement of tone quality in mind. Together, they permit the AU-888 to deliver a full 140 watts ( $4\Omega$ ) in music power output with unprecedentedly good tone quality.

The AU-888 is lavishly endowed with accessory circuits. These include a Midrange Tone Selector an improved form of the Triple Tone Control circuit that offers a choice in selecting the critical frequencies of tone control; a Speaker Selector which permits connecting three sets of speaker systems; a facilities to connect two phonographs and two tape decks; and a tape reprint circuit which makes it possible to copy a recorded tape by utilizing two tape decks. Special provisions have also been made to permit the amplifier to be built up into an electronic crossover stereo system and permit comparing such a system with a standard stereo setup.

From the superior performance characteristics to the careful finish of control knobs, Sansui's tradition of quality is evident. Packed with the most advanced circuits throughout, the AU-888 comes to you with the full confidence and guarantee of the manufacturer.

It is now up to you to read the contents of this manual carefully before setting out to use it, so you may operate it correctly and obtain the maximum performance it is capable of offering for many years to come.

## CONTENTS

---

SWITCHES AND CONTROLS.....	3, 4, 5, 6
OPERATIONS .....	7, 8
—SPEAKER CONNECTIONS	
—RECORD PLAYING	
OPERATIONS .....	9, 10
—RADIO RECEPTION	
—MICROPHONE	
OPERATIONS .....	11, 12
—TAPE PLAYBACK	
—TAPE RECORDING	
ELECTRONIC CROSSOVER SYSTEM .....	13, 14
MAINTENANCE .....	15, 16, 17
SPECIFICATIONS.....	18
CHARACTERISTICS/ACCESSORIES.....	19, 20
TROUBLESHOOTING CHART .....	21, 22
DISASSEMBLY PROCEDURE/TEST POINTS.....	23
ALIGNMENT .....	24
BLOCK DIAGRAM .....	25
PRINTED CIRCUIT BOARDS AND PARTS LIST.....	26, 27, 28, 29, 30, 31
OTHER PARTS AND THEIR POSITION ON CHASSIS .....	32, 33, 34

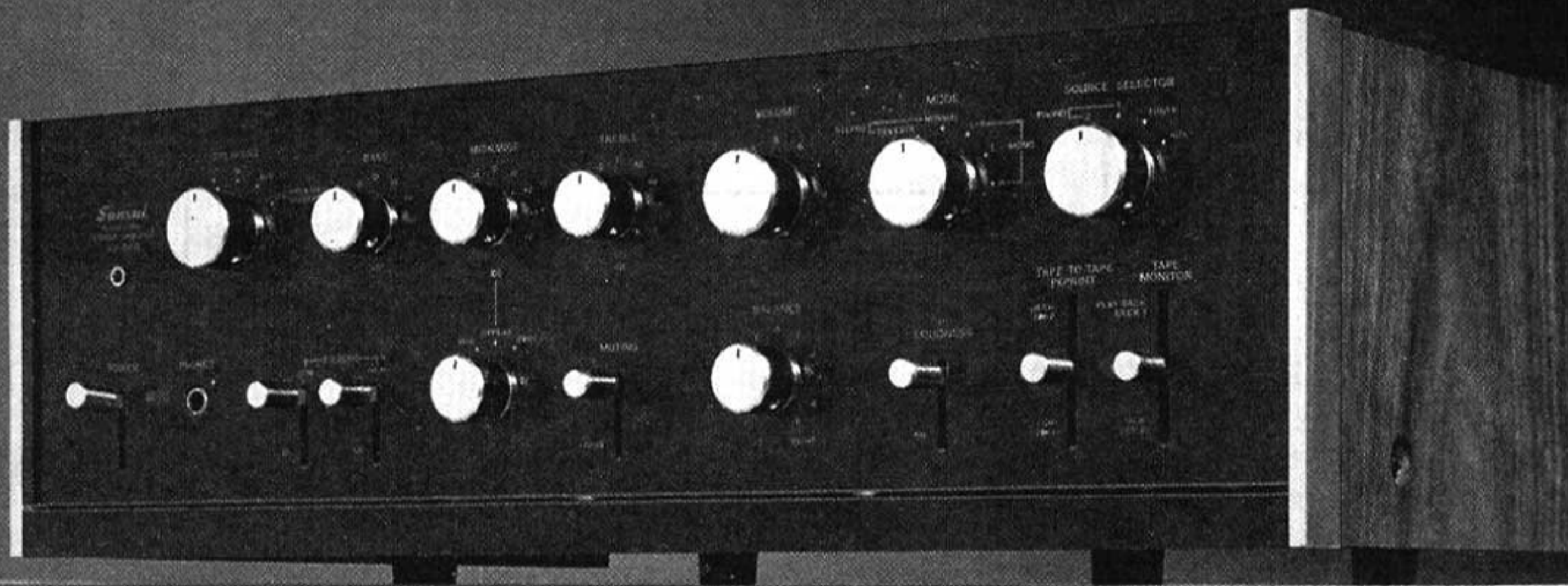

# SWITCHES AND CONTROLS

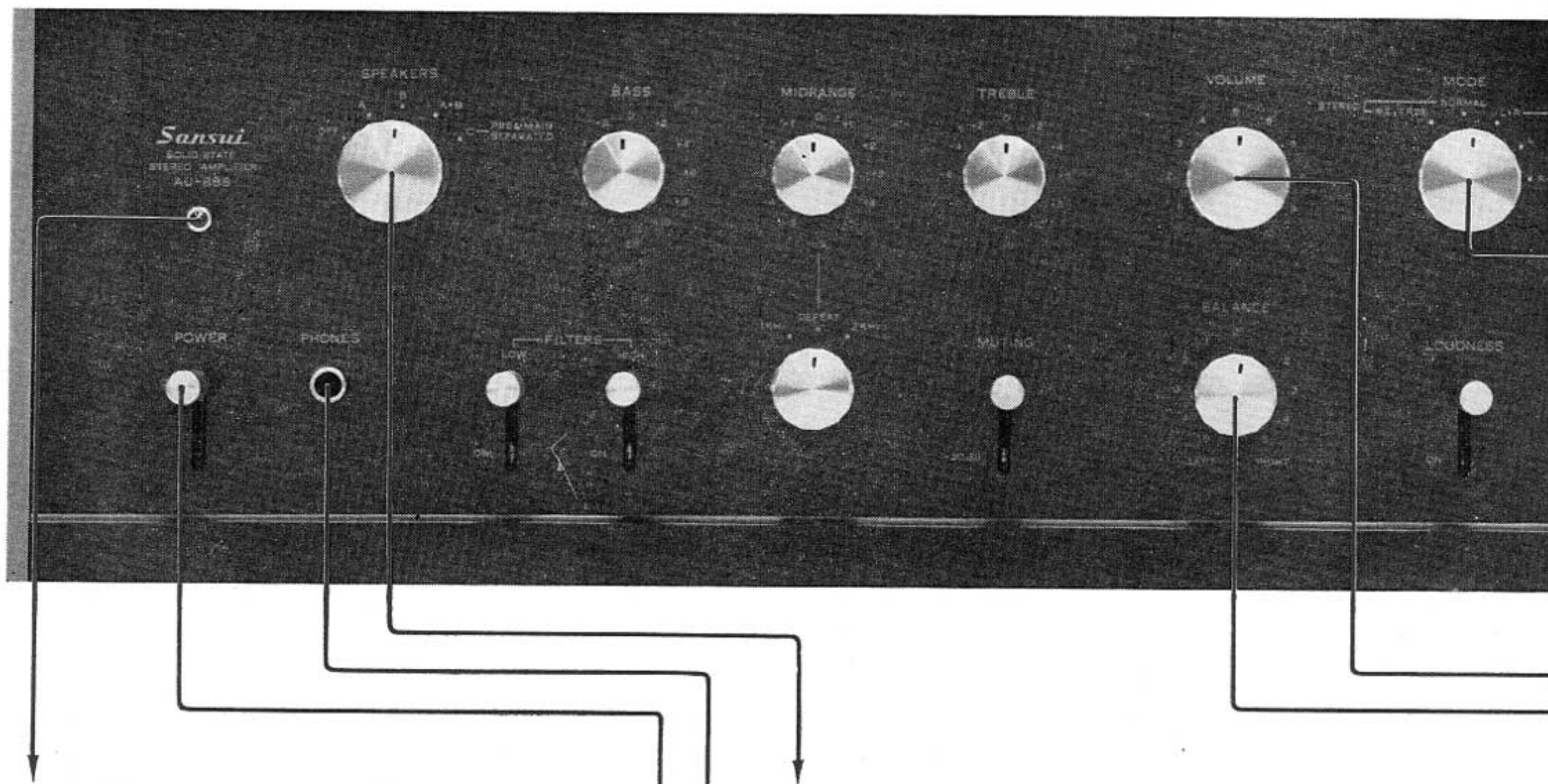

## Power Indicator

The Power indicator is lit when the POWER switch is turned on. It remains lit while the amplifier is on.

## Power Switch

Power is applied to the amplifier when the POWER switch is set in its up position. This switch controls any other components connected to the upper two AC outlets on the rear panel.

## Headphones Jack

Plug a stereo headset into this jack for private listening or monitoring. Before using for private listening, turn the SPEAKERS switch to its OFF position. This jack will accept any standard stereo phone plug, but a dynamic headset is recommended.

## Speakers Switch

Three pairs of speakers can be connected to the amplifier. You can install the main set of speakers (System A) in your listening room and additional speakers (System B and C) in the same room or remotely in other rooms of your home. With the P-M connector removed, the amplifier and the speakers connected to the System C outputs can be used as a component of the Electronic Crossover System.

**OFF:** All speakers connected to the amplifier are muted for private listening with headphones connected to the PHONES jack.

**SYSTEM A:** Selects the speakers connected to the System A terminals.

**SYSTEM B:** Selects the speakers connected to the System B terminals.

**SYSTEM A+B:** Selects the A and B speakers simultaneously.

**SYSTEM C:** Selects the speakers connected to the System C terminals.

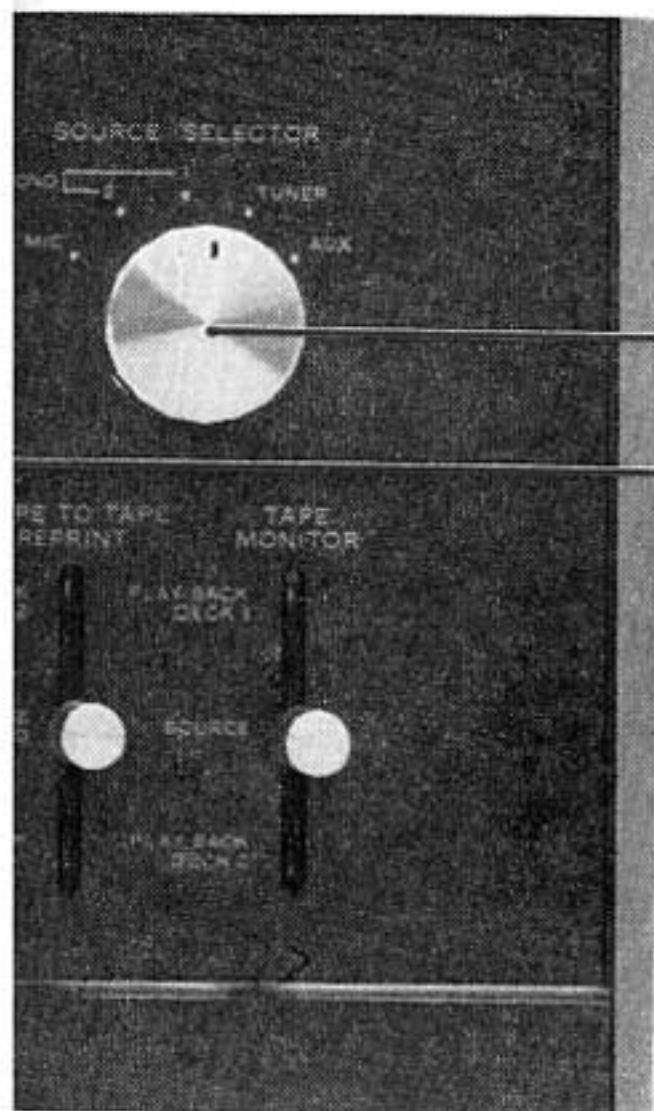

## Source Selector Switch

This switch selects from among the various program sources connected to the input jacks on the rear panel of the amplifier.

**MIC:** Selects a 50k $\Omega$  microphone or microphones connected to the MIC inputs.

**PHONO 2:** Selects a record player having a 30, 50 or 100k $\Omega$  cartridge connected to the PHONO 2 inputs.

**PHONO 1:** Selects a record player 50k $\Omega$  cartridge connected to the PHONO 1 inputs.

**TUNER:** Selects a tuner connected to the TUNER inputs.

**AUX:** Selects other components connected AUX inputs.

## Volume Control

This control adjusts the over-all sound level of both channels. Turn it clockwise, and the volume is increased; and vice versa.

## Balance Control

This control adjusts for equal sound from both left and right channels to compensate for slight imperfections in program material, variations in speaker output, and the vagaries of room acoustics.

## Mode Switch

**STEREO REVERSE:** Use this position if the channels of a stereo program are reversed. The MODE switch connects the left input to the right speaker and the right input to the left speaker.

**STEREO NORMAL:** Use this position if the stereo program is normal. The MODE switch connects the left input to the left speaker and the right input to the right speaker.

**MONO L+R:** The MODE switch in this position connects the left and right inputs to both speakers.

**MONO L:** The MODE switch in this position connects the left input to both speakers.

**MONO R:** The MODE switch in this position connects the right input to both speakers.

# SWITCHES AND CONTROLS

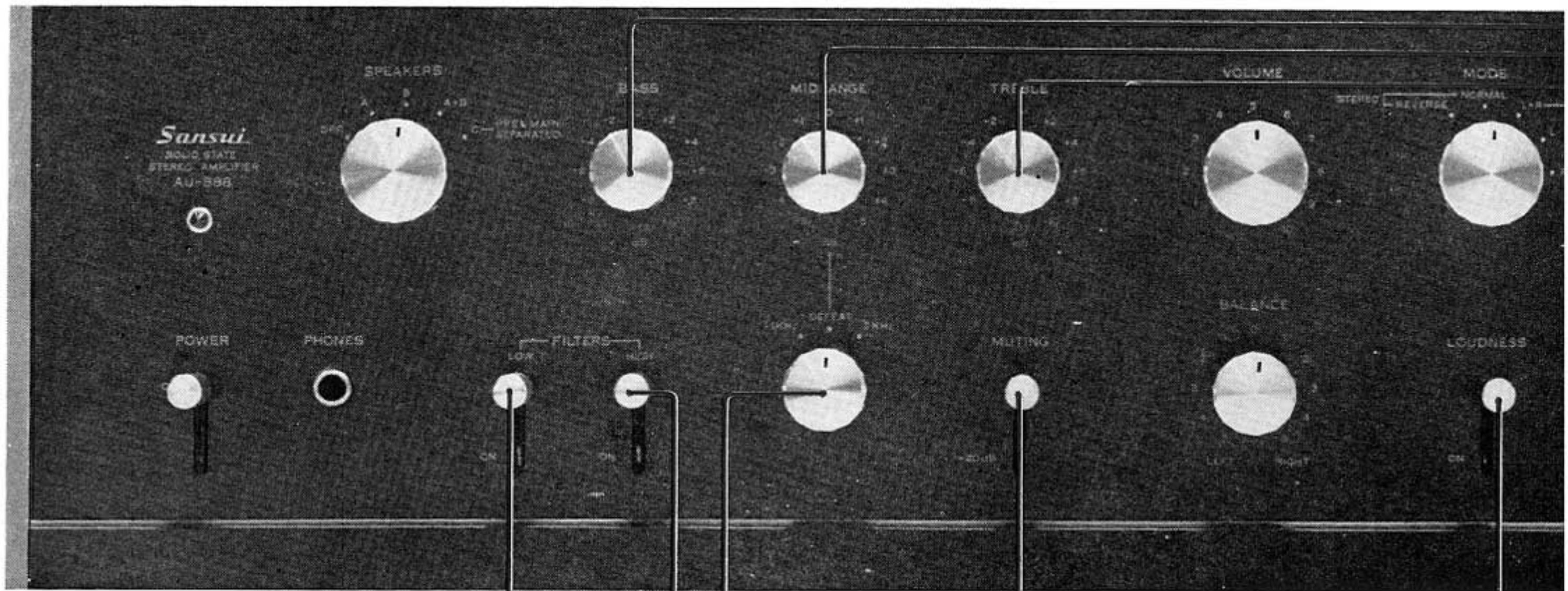

## Low Filter

Turntable rumble and other low-frequency noises are reduced by setting the LOW FILTER switch to the down or ON position.

## High Filter

Surface noise from old or worn records, tape hiss and other high-frequency noises are reduced by setting the HIGH FILTER switch to the down or ON position.

## Midrange Tone Selector

This switch selects the frequency at which the MIDRANGE control begins to cut or boost.

**DEFEAT:** Use this position for flat response at mid-frequencies.

**1 kHz:** The MIDRANGE control begins to cut or boost the midrange at 1000 Hz.

**2 kHz:** The MIDRANGE control begins to cut or boost the midrange at 2000 Hz.

## Muting Switch

The MUTING switch attenuates music and voice by 20 dB over the whole frequency range without use of the VOLUME control. This switch is used to suppress the background noise heard when changing a record, and to reduce the over-all sound level temporarily while playing a record.

## Loudness Switch

Whenever the volume is decreased to a low listening level, the music will seem to lose much of its bass and some of its treble. This effect is due to the sensitivity of human hearing. When the LOUDNESS switch is on, it provides the correct amount of bass and treble boost required to compensate for this change.

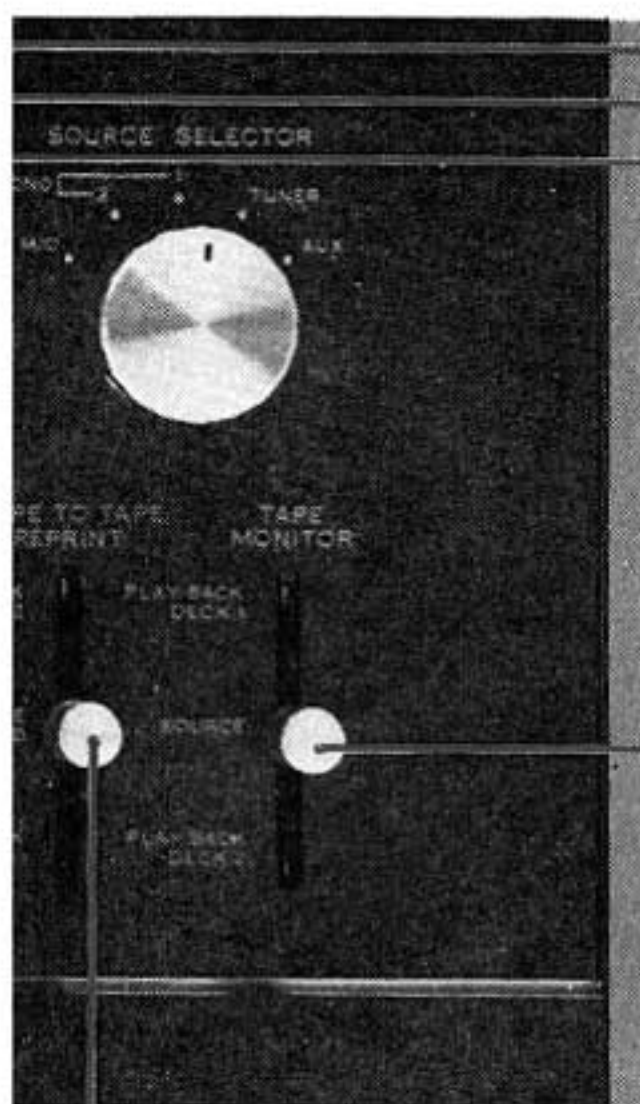

### Tape-to-Tape Reprint

When connecting two tape decks to the amplifier, this switch allows tape-to-tape recording.

**DECK 1 ► 2:** Use this position for recording from tape deck 1 to tape deck 2.

**SOURCE RECORD:** With the switch in this position, any program source selected by the SOURCE SELECTOR switch can be recorded by either deck 1 or 2, or by both decks simultaneously.

**DECK 2 ► 1:** Use this position for recording from tape deck 2 to tape deck 1.

**Note:** During the tape-to-tape reprinting process, monitoring is possible on either recording or playback side by setting the TAPE MONITOR switch to the DECK 1 or DECK 2 position. When the TAPE MONITOR switch is returned to the SOURCE position, it is possible to play a record as usual while reprinting.

### Bass Control

This control determines the amount of bass tones in both channels. When the marker is centered at the 0 position, the response curve is flat. The control emphasizes the bass tone by 2 dB per step as it is turned clockwise. To decrease the bass loudness, turn it counterclockwise.

### Midrange Control

This control determines the amount of midrange in both channels. When the marker is centered at the 0 position, the response curve is flat. The control emphasizes the midrange by 1 dB per step as it is turned clockwise. To decrease the midrange loudness, turn it counterclockwise.

### Treble Control

This control determines the amount of treble tone in both channels. When the marker is centered at the 0 position, the response curve is flat. The control emphasizes the treble tone by 2 dB per step as it is turned clockwise. To decrease the treble loudness, turn it counterclockwise.

### Tape Monitor Switch

Two stereo tape decks can be connected to the amplifier. When using 3-head tape decks, this switch allows recording directly from any program set up on the amplifier, and at the same time allows listening to the actual recording as picked up by the playback head.

**DECK 1:** Selects the tape deck connected to the TAPE 1 or TAPE RECORDER jacks.

**DECK 2:** Selects the tape deck connected to the TAPE 2 jacks.

When not in use, make sure the switch is in the SOURCE position.

# OPERATIONS

## — SPEAKER CONNECTIONS

## — RECORD PLAYING

### Connecting Loudspeakers

Three pairs of 4- to 16-ohm speakers can be connected to the amplifier. One set of speakers connected to the SYSTEM A terminals may be installed in your listening room and two other sets of speakers connected to the SYSTEM B and C outputs may be installed in other rooms of your home. The SPEAKERS switch selects from among the A, B and C speakers. When it is set to the SYSTEM A+B position, you will hear sound from both speaker systems. Only the C speakers can be used as a component of the Electronic Crossover System. A detailed description will be found in the section entitled **Electronic Crossover System**.

To connect the main set of speakers to the amplifier:

1. Connect the positive terminal of the speaker on your left (as viewed from the listening area) to the left channel SYSTEM A '+' terminal on the rear of the amplifier.
2. Connect the lead from the common terminal (marked '-') of the speaker left to the left channel SYSTEM A '-' terminal on the rear of the amplifier.
3. The right speaker connections are made at the right channel SYSTEM A terminals on the rear of the amplifier in the manner described above.
4. Set the SPEAKERS switch to SYSTEM A.

In connecting speakers to the amplifier, no more than  $\frac{1}{4}$ -inch of insulation should be removed from the end of a speaker cable, since any greater length of exposed wire is likely to cause shorts at the terminals. All wire strands should be tightly twisted. To connect, depress the terminal button with one hand, push the stripped end of lead wire in the hole with the other hand, and release the button.

If you wish to connect one or two more sets of speakers in the same room or remotely, you can connect such speakers to the SYSTEM B and C terminals of each channel as indicated above. To listen to sound from the B or C speakers, be sure

to turn the SPEAKERS switch to the SYSTEM B or C position respectively.

**CAUTION:** When you connect one set of speakers to the SYSTEM A terminals and another set of speakers to the SYSTEM B in order to use them simultaneously with the Speakers switch set in its SYSTEM A+B position, each speaker must have impedance of 8 ohms or more. If a 4 ohm impedance speaker is used, the amplifier may be damaged.

### RECORD PLAYERS

#### Connecting Record Players

The AU-888 has two sets of PHONO inputs to accommodate a pair of players. The PHONO 1 has the input impedance of 50 k $\Omega$ . The PHONO 2 can be switched between 30, 50 and 100 k $\Omega$  by means of the PICKUP LOAD switch on the rear panel.

To connect a record player to the amplifier, proceed as follows:

1. Connect the left channel output of the record player to the LEFT PHONO 1 (or PHONO 2) input jack on the rear of the amplifier.
2. Connect the right channel output of the record player to the RIGHT PHONO 1 (or PHONO 2) input jack.
3. If a monophonic player or turntable is used, it may be connected to either LEFT or RIGHT PHONO input jack.

#### Listening to a Stereo or Mono Record

1. Set the SOURCE SELECTOR switch to PHONO 1 or PHONO 2 depending on which input is being used.
2. Set the MODE switch to STEREO. If a monophonic record player is used, set the MODE switch to MONO.
3. Make appropriate settings of controls on the record player.
4. Place the needle on the record.
5. Adjust the BALANCE control for equal sound



from both right and left speakers.

**6.** Use all other controls and switches according to your personal taste and room acoustics.

**Note:** When monophonic records are played on a stereo player, follow the same procedures as for

stereophonic records for better results.

Insert the power-cord plug of the player into one of the two A.C. outlets marked SWITCHED on the rear of the amplifier. The power supply will then be controlled by the front POWER switch.

==== LEFT CHANNEL  
 ——— RIGHT CHANNEL

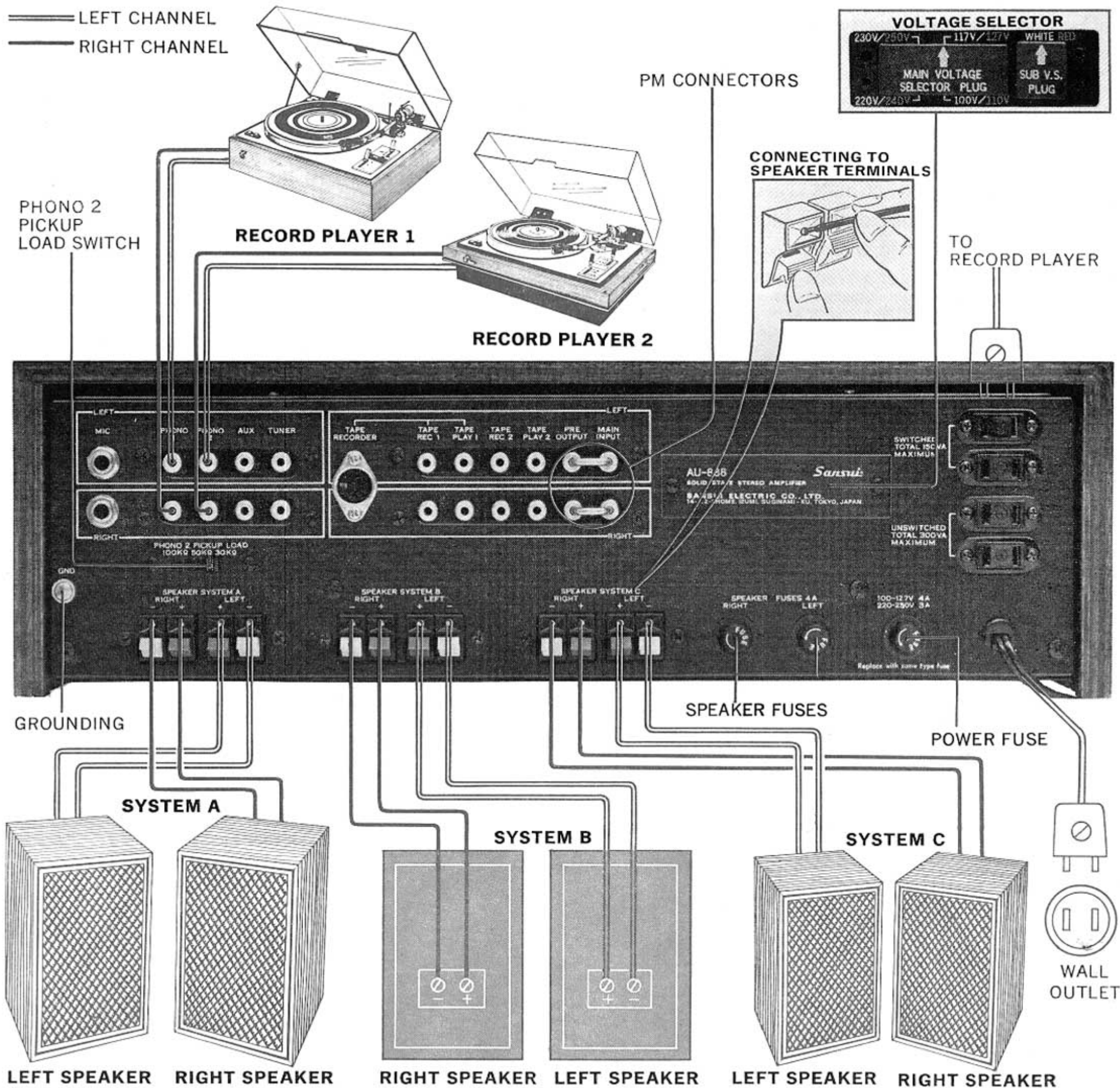

# OPERATIONS

## RADIO RECEPTION MICROPHONE

### TUNERS

#### Connecting Tuners

For a stereo tuner, connect its left channel output to the left channel TUNER input jack, and its right channel output to the right channel TUNER input jack. For a monophonic tuner, connect its output to either left or right jack.

#### Listening to a Stereo FM Program

1. Set the SOURCE SELECTOR switch to TUNER.
2. Set the MODE switch to STEREO.
3. Use tuning controls to reach the desired station. Make appropriate settings of controls on the tuner.
4. Adjust the amplifier's front panel controls and switches according to your personal taste and room acoustics.

#### Listening to a Mono Program

1. Set the SOURCE SELECTOR switch to TUNER.
2. Set the MODE switch to MONO.
3. Use tuning controls to reach the desired station. Make appropriate settings of controls on the tuner.
4. Adjust the amplifier's front panel controls and switches according to your personal taste and room acoustics.

### MICROPHONES

One or two microphones can be connected to the MIC inputs on the rear of the amplifier. Use highimpedance 50-k $\Omega$  dynamic microphones for optimum performance.

#### Connections

If two microphones are used, connect one to the RIGHT MIC input and the other to the LEFT. If only one microphone is used, connect it to either RIGHT or LEFT MIC input.

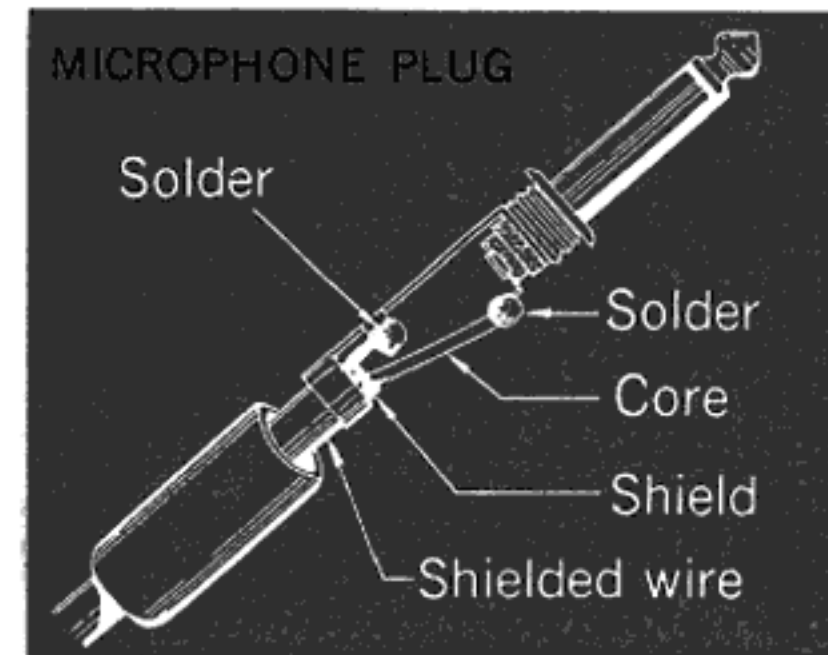

#### Operation

1. Set the SOURCE SELECTOR switch to MIC.
2. If two microphones are used, set the MODE switch to MONO L+R for mixing the two input signals or to STEREO for separate use of the two microphones. If only one microphone is used, set the MODE switch to MONO L or MONO R depending on which input is being used.
3. Use all other controls and switches according to your personal taste and room acoustics.

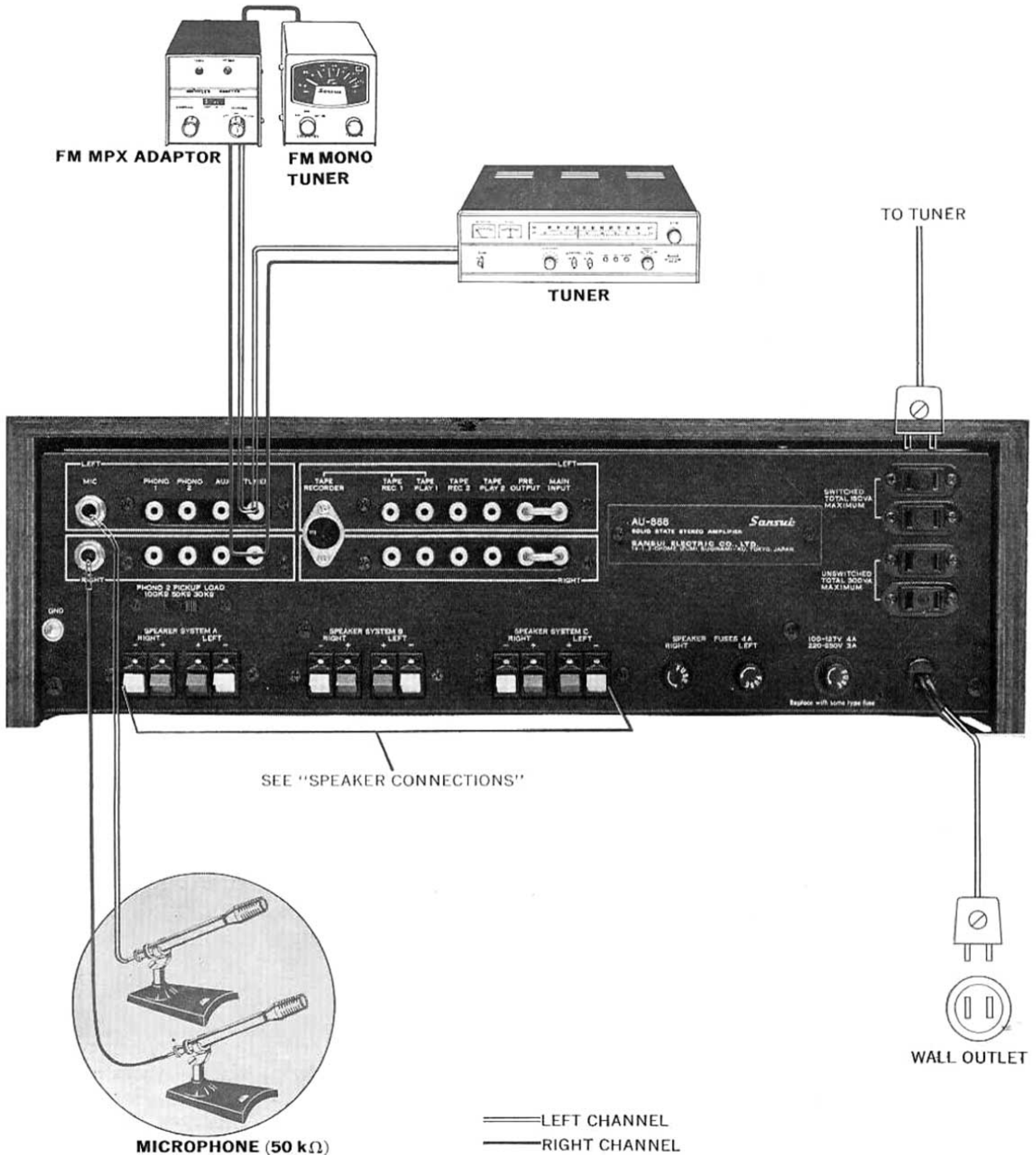

# OPERATIONS

## — TAPE PLAYBACK — TAPE RECORDING

### TAPE DECKS

#### Connecting Tape Decks

Tape decks can be connected to record from, and playback through, the AU-888. Tape monitoring is possible with a tape machine having a built-in preamplifier as well as separate recording and playback heads.

#### Tape Deck with DIN Connector

If your tape deck has a DIN (German Industrial Standard) 5-pin plug, plug it into the TAPE RECORDER socket on the rear panel of the amplifier. **Caution:** The tape deck having a DIN connector must not be used together with another tape deck connected to the TAPE 1 jacks. To use both decks simultaneously, the latter tape deck should be connected to the TAPE 2 jacks.

#### Tape Deck with Pin-Jack Connector

To record on tapes from the amplifier:

1. Connect the left channel input of the tape deck to the left channel TAPE 1 (or 2) REC jack on the rear of the amplifier.
2. Connect the right channel input of the tape deck to the right channel TAPE 1 (or 2) REC jack.
3. If a monophonic tape deck is used, it may be connected to either left or right TAPE REC jack.

To playback through the amplifier:

1. Connect the left channel output of the tape deck to the left channel TAPE 1 (or 2) PLAY jack on the rear of the amplifier.
2. Connect the right channel output of the tape deck to the right channel TAPE 1 (or 2) PLAY jack.
3. If a monophonic tape deck is used, it may be connected to either left or right TAPE PLAY jack.

#### Recording on Tapes

1. Set the SOURCE SELECTOR switch to the program to be recorded.
2. Set the MODE switch to STEREO. If a mono-

phonic tape deck is used, set the switch to MONO.

3. Make appropriate settings of controls on the tape deck.

To record on two tapes simultaneously by using two tape decks connected to the TAPE 1 and 2 jacks:

1. Set the SOURCE SELECTOR switch to the program to be recorded.
2. Set the TAPE-TO-TAPE REPRINT switch to SOURCE RECORD.
3. Set the tape decks in the recording mode.
4. Use other controls and switches appropriately.

#### Listening to Tapes

1. Turn the TAPE MONITOR switch to PLAYBACK DECK 1 or 2.
2. Set the MODE switch to STEREO. If a monophonic tape deck is used, set the switch to MONO.
3. Make appropriate settings of controls on the tape deck.
4. Use the amplifier's front panel controls and switches according to your personal taste and listening conditions.

#### Tape Monitoring

Monitoring is possible only with a tape deck which has its own playback preamplifier as well as separate recording and playback heads. Set the TAPE MONITOR switch to PLAYBACK and use all other controls and switches according to your personal taste and listening conditions.

#### Tape-to-Tape Reprinting

To record from the tape deck connected to the TAPE 1 jacks to the tape deck connected to the TAPE 2 jacks:

1. Turn the TAPE-TO-TAPE REPRINT switch to DECK 1 ► 2.
2. Set the tape deck 2 in the recording mode.
3. Set the tape deck 1 in the playback mode.
4. Use other controls and switches appropriately.

To record from the tape deck 2 to the tape deck 1:

1. Turn the TAPE-TO-TAPE REPRINT switch to DECK 2 ► 1.
2. Set the tape deck 1 in the recording mode.
3. Set tee tape deck 2 in the playback mode.
4. Use other controls and switches appropriately.

**Notes:**

1. Tape recorded sound cannot be controlled by the controls and switches on the front panel of the amplifier. They control sound from the speakers only.
2. For better results, record directly through the

AU-888 rather than through microphones placed in front of the speakers.

3. Before connecting and operating the tape decks, be sure to look up the manufacturer's operating instructions.

4. The TAPE MONITOR switch should be in the SOURCE position except when the tapes are being monitored or played back by the tape deck. When the switch is in the PLAY BACK position, signals from any other source will not be heard from the speakers.

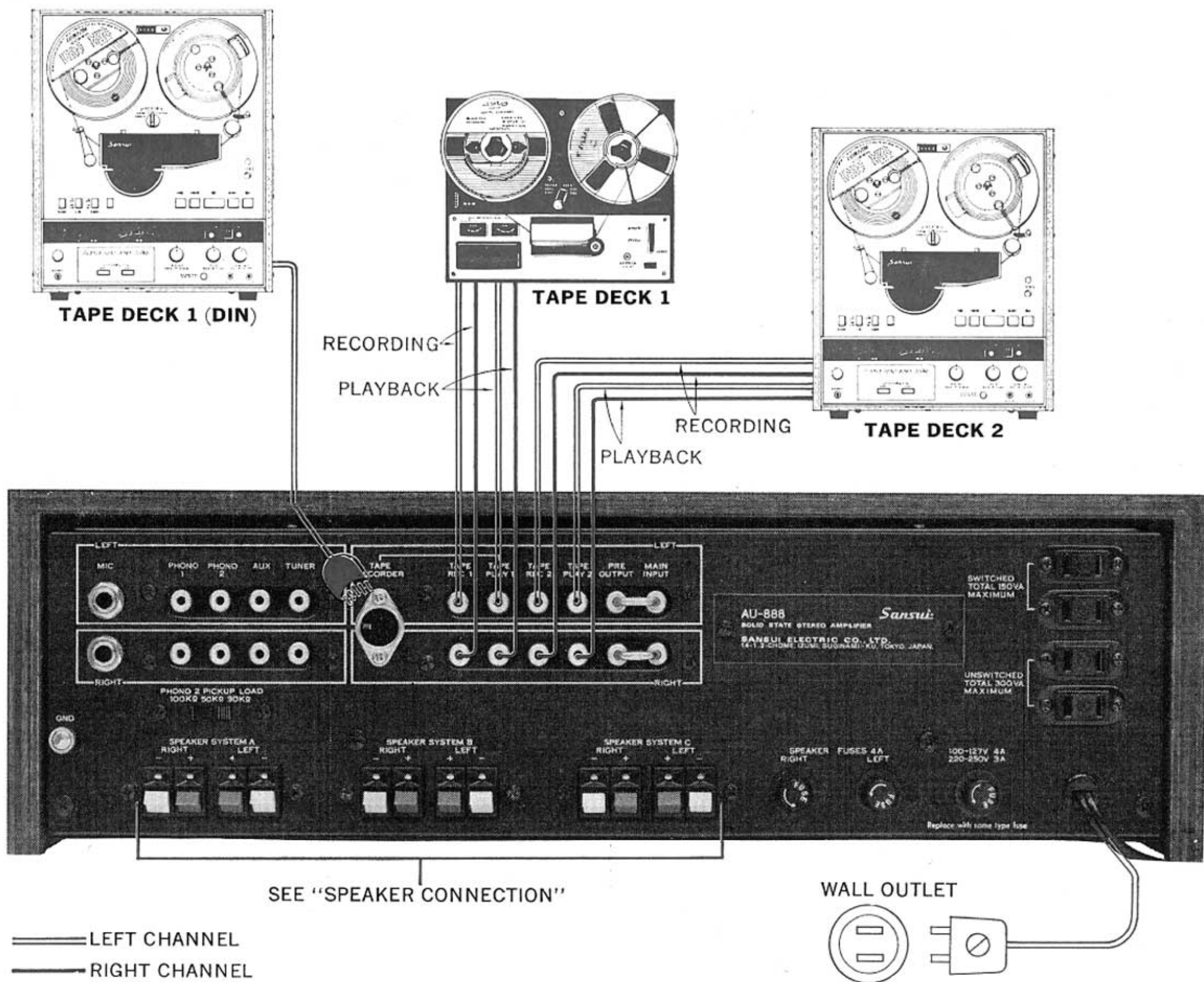

# ELECTRONIC CROSSOVER SYSTEM

## Electronic Crossover System

The electronic crossover system is said to be the best hi-fi sound reproduction method available, featuring the following advantages:

1. Since the tweeters, midranges and woofers have their own amplifier, any speakers of different impedance and efficiency can be used for stereo arrangement.
2. This system has better filter characteristics than the conventional LC crossover network. You can determine the optimum crossover points for the speakers used.
3. Since there is no component between the amplifier and speaker, the damping factor of the amplifier is not affected and it is directly coupled to the speaker.
4. This system allows use of the power amplifiers effectively and efficiently. For instance, a big-power amplifier can be used for woofers, and ones with good characteristics for midranges and tweeters. You can select the amplifiers suitable for each of the woofers, midranges and tweeters.

The AU-888's preamp and main amplifier sections can be used separately by simply removing a pair of connectors (PM connectors) from the PRE OUTPUT and MAIN INPUT jacks on the rear panel. This feature enables you to use the AU-888 as a component of an Electronic Crossover System in the following manner:

1. Set the SPEAKERS switch to SYSTEM C.
2. Remove the PM connectors from the PRE OUTPUT and MAIN INPUT jacks.
3. Connect an electronic crossover unit (Sansui CD-5) to the PRE OUTPUT jacks.
4. Connect the low-frequency output of the electronic crossover unit to the MAIN INPUT jacks on the AU-888.
5. Connect the right and left woofers to the SYSTEM C terminals on the AU-888.
6. Connect the mid-frequency output of the electronic crossover unit to the inputs of the second separate power amplifier (Sansui BA-90), and the

right and left midrange speakers to the said power amplifier.

7. Connect the high-frequency output of the electronic crossover unit to the inputs of the third separate power amplifier (Sansui BA-90), and the right and left tweeters to the said power amplifier.

### Notes:

1. You can connect speakers to the SYSTEM A and B terminals in addition to the SYSTEM C and directly compare the sound of the Electronic Crossover System with that of the ordinary stereo arrangement by turning the SPEAKERS switch between the SYSTEM A, B and C positions.
2. The connection of an additional pre-amplifier to the MAIN INPUT jacks cuts off all front panel switches and controls except the SPEAKERS switches. Thus, to adjust the tone and volume, operate the controls of the additional preamplifier connected to the AU-888. When an additional power amplifier is connected to the PRE OUTPUT jacks, the tone and volume can be adjusted by the controls of the AU-888.

# ELECTRONIC CROSSOVER SYSTEM

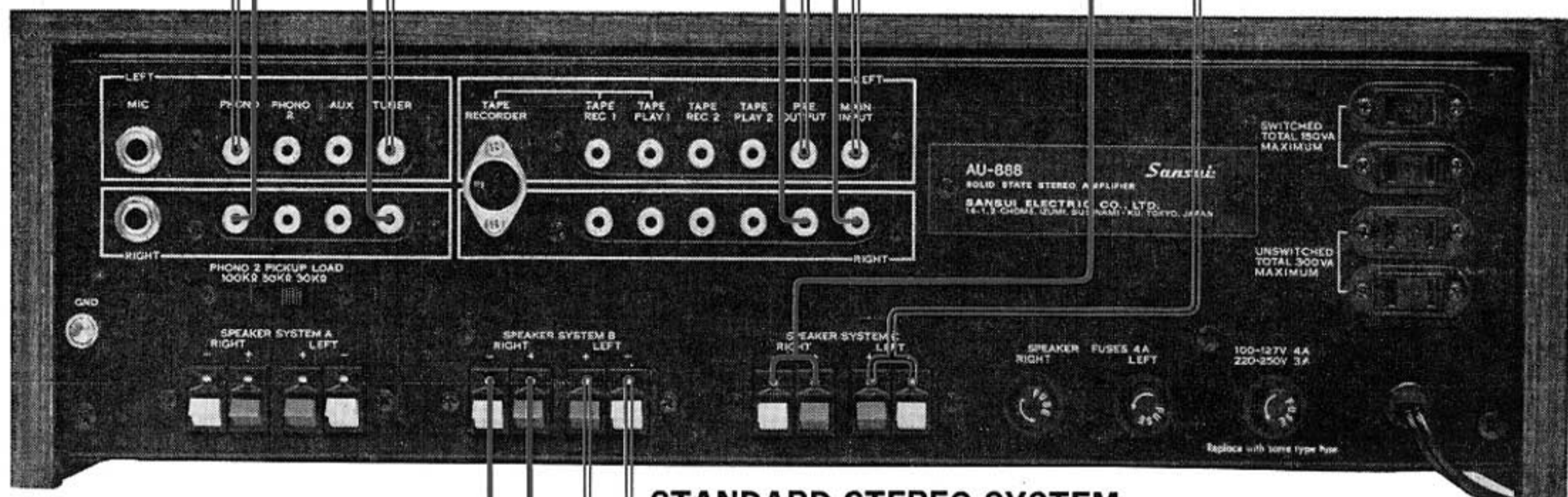
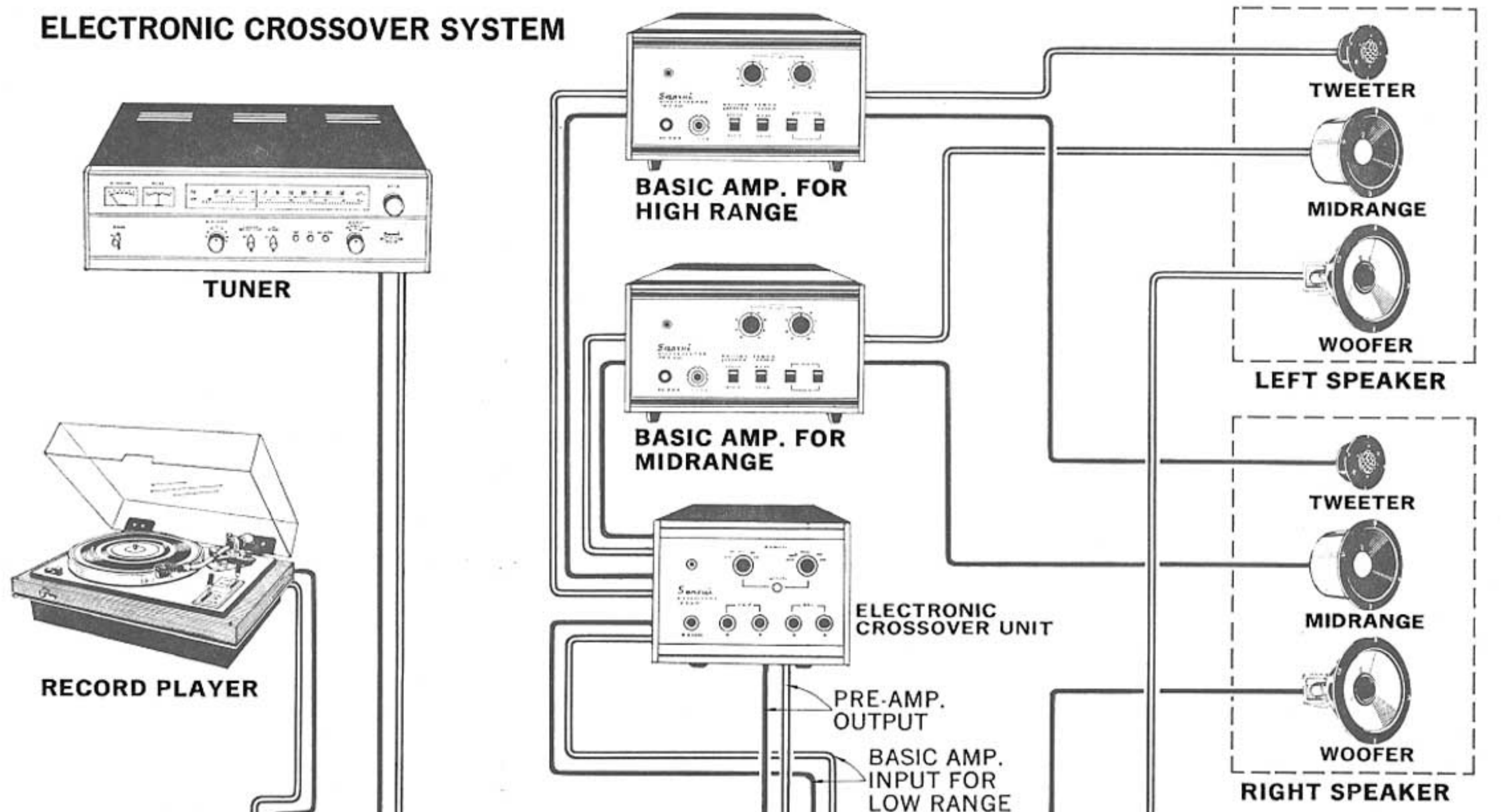

# STANDARD STEREO SYSTEM

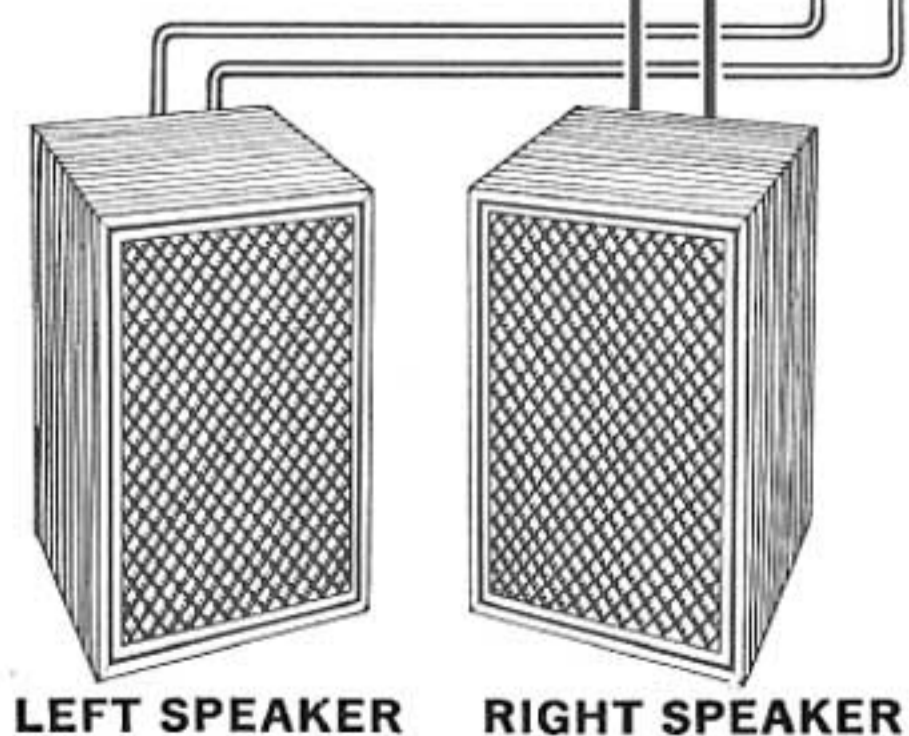

==== LEFT CHANNEL  
 ——— RIGHT CHANNEL

# MAINTENANCE

## PM Connectors

**Warning:** Be sure to turn the *POWER* switch *OFF* before removing the *PM* connectors.

The *PM* connectors hook up the *PRE OUTPUT* and *MAIN INPUT* terminals on the rear panel of the amplifier. When the *PM* connectors are removed with the *SPEAKERS* switch set in the *SYSTEM C* position, the pre-and main amplifier sections can be used individually and separately. They should not be removed except when connecting additional pre- and/or main amplifiers. Refer to the section entitled *Electronic Crossover System*.

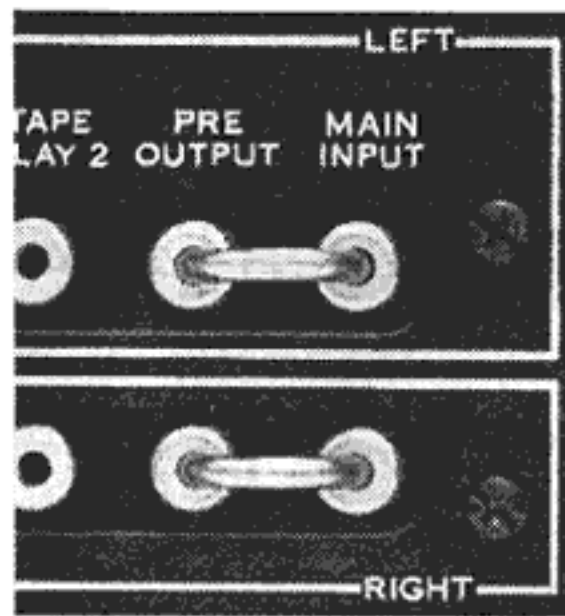

## Connecting Wire

Be sure to use adequately thick shieldwire when connecting tape decks, record players or other components to the AU-888. The use of an ordinary twin leadwire may cause hum or noise. Don't use shieldwire longer than 7 feet (2 meters). The use of a longer wire leads to greater attenuation at high frequencies.

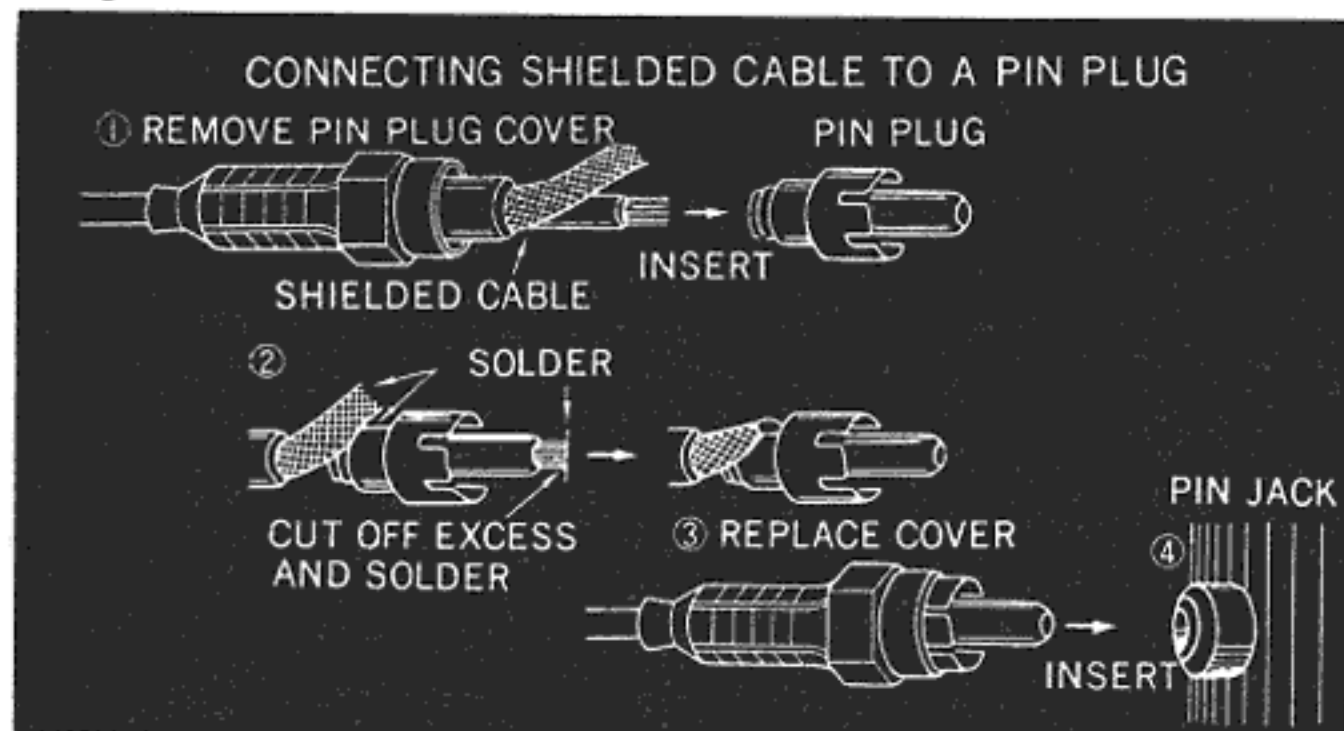

## Connections

Always check to see that leads are connected firmly and properly to their corresponding output or input

terminals. If the connections are loose or in touch with other parts, the AU-888 will not perform normally, and may produce undesirable noise. If used in such a way for a long time, it will eventually break down. Always read the manufacturer's instructions for tape decks, record players, etc. before connecting.

## Where to Place

Since transistors are extremely susceptible to heat, the AU-888 has been designed to diffuse heat through the top and rear of its case. Therefore, special consideration should be given to where it will be used before installing the system. It should not be operated in a place where it is exposed directly to the sun, near radiators or other heat-generating sources, and it should never be mounted in an air-tight cabinet. Finally, nothing should be placed on top of it.

## Hum and Howling

If, when using a tape deck or record player, unpleasant humming or howling is heard, it is usually a result of the following.

The record player is placed on or near the speaker box causing sound waves to be transmitted from the speaker to the player (howling). To prevent this, place the record player away from the speaker box or put a thick cushion between the two components.

A low buzzing sound will also be produced if adequately thick shieldwire is not used for connections, or if connections have not been properly made. Be sure that the shieldwire is properly soldered to the pin-plugs as illustrated in "Connecting Wire", and that the motor and pickup arm or the record player are properly grounded.

## Speaker Impedance

Combined impedance of speakers in each channel should not be less than 4 ohms. Too low impedance may blow quick-acting fuses or may cause damage to the amplifier after use over a long period.



## Phasing of Speakers

Stand about 10 feet in front of and midway between the speakers and listen to any monophonic reproduction. If the speakers are correctly phased, the sound will seem to come from between the speakers. If the sound is not directly in front of you, the speakers are incorrectly phased. To correct this, switch the amplifier off and reverse the leads to one speaker.

Care should be taken not to connect a single speaker system between the SYSTEM A and B terminals.

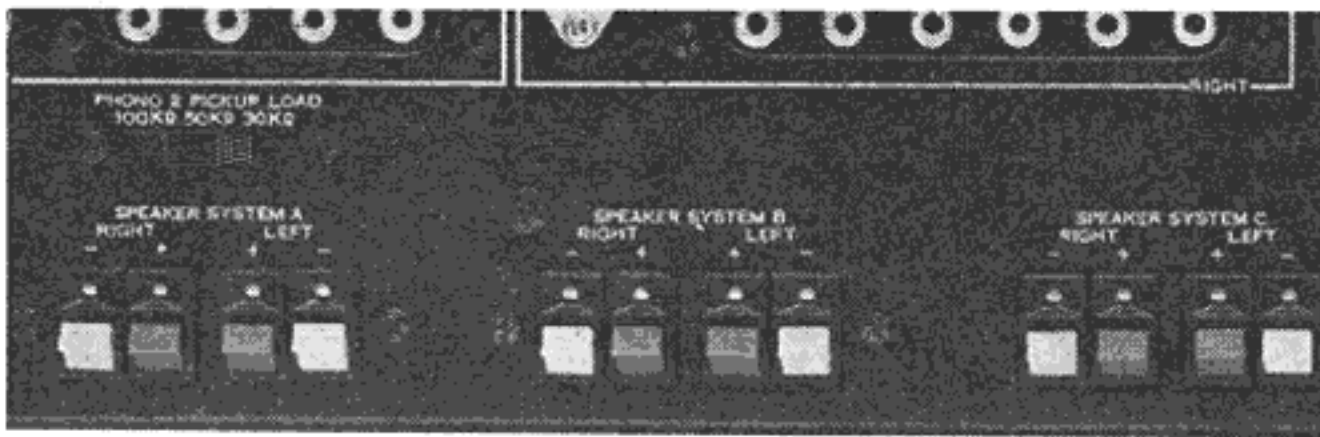

## Grounding

Connect one end of vinyl or enameled wire to the terminal screw marked GND on the rear of the amplifier, attach a copper plate to the other end and bury it underground. Whenever an outdoor AM antenna is used, grounding becomes necessary. In all cases, grounding is desirable since it allows a better SN ratio to be obtained. To ground an entire audio system, connect the grounding wire of each component used to this terminal.

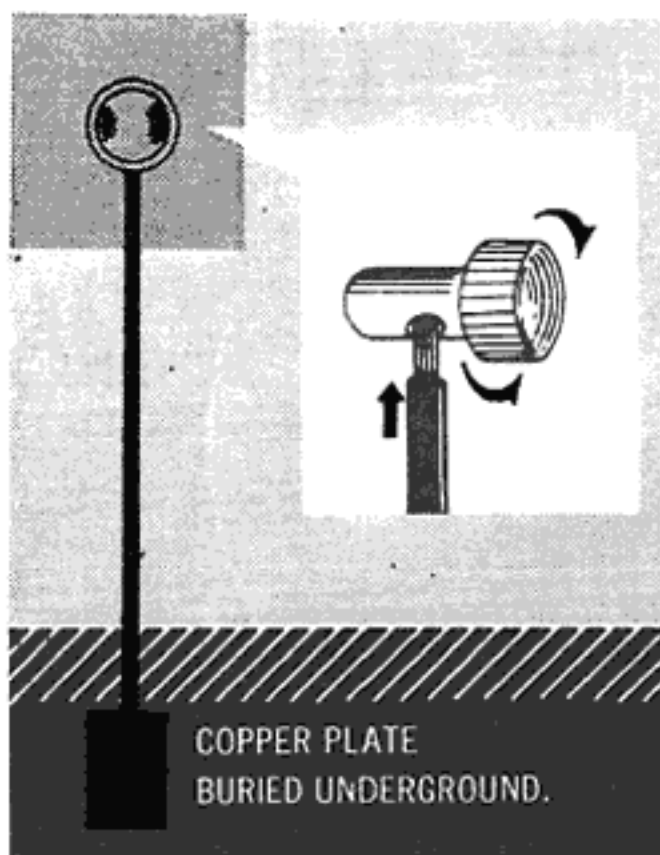

## Quick-Acting Fuses

The AU-888 is double protected by the quick-acting fuses at every power transistor stage and in the output circuit. If sound from the speakers is distorted or not heard at all, immediately remove the power plug from its outlet; check for the blown SPEAKER FUSES on the rear panel; and, if necessary, replace them with the new 4-ampere fuses (supplied). If OK, remove the bonnet from the AU-888; check the inside fuses; and, if necessary, replace them with the new 4-ampere fuses (supplied). Before replacing, check for the source of trouble that caused the fuses to blow. If the new fuses blow as soon as the POWER switch is turned on, check for the defective power circuit. If the trouble source cannot be located, contact the nearest Sansui dealer or Authorized Service Station.

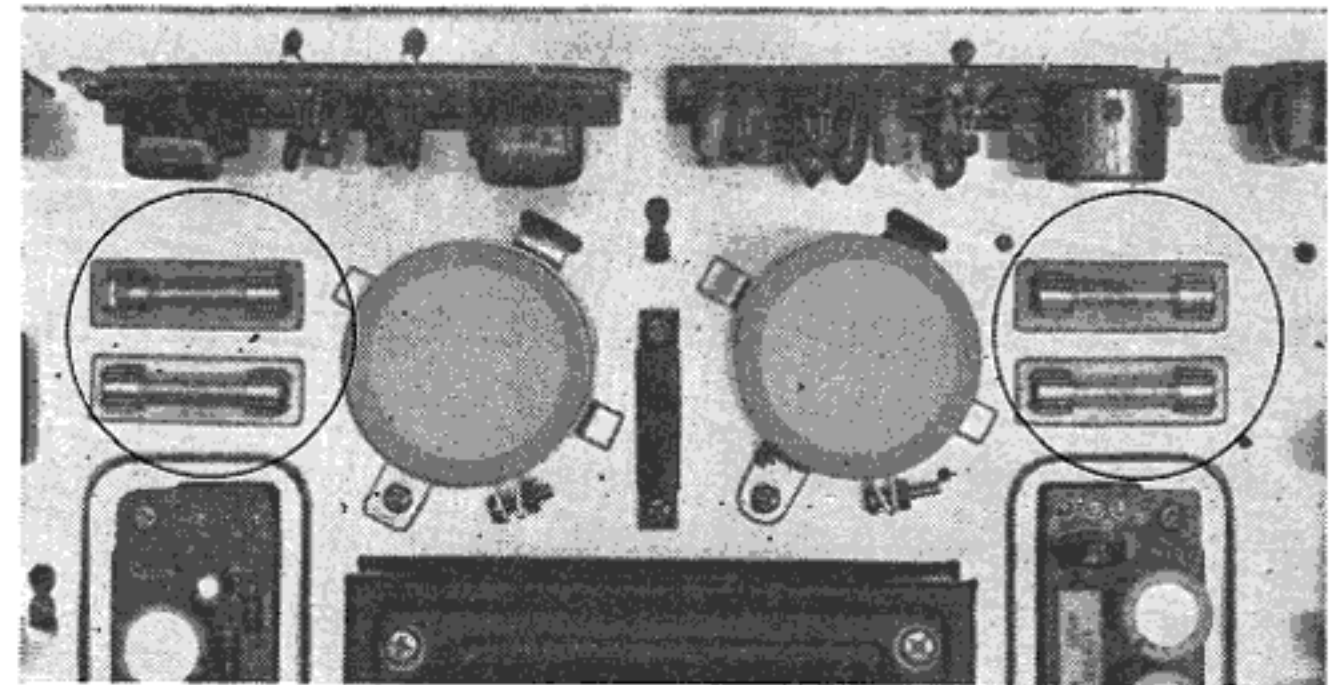
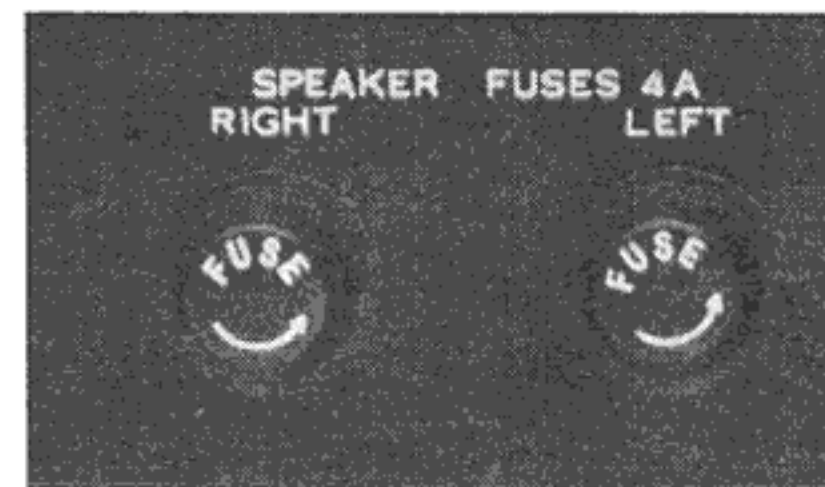

# MAINTENANCE

## A.C. Outlets

The AU-888 is provided with four A.C. outlets on its rear panel. The upper two outlets marked SWITCHED are switched on and off by the POWER switch on the front panel.

**Caution:** The upper two outlets have a maximum capacity of 150 VA total and the two other outlets 300 VA total. Never use them beyond their rated capacities.

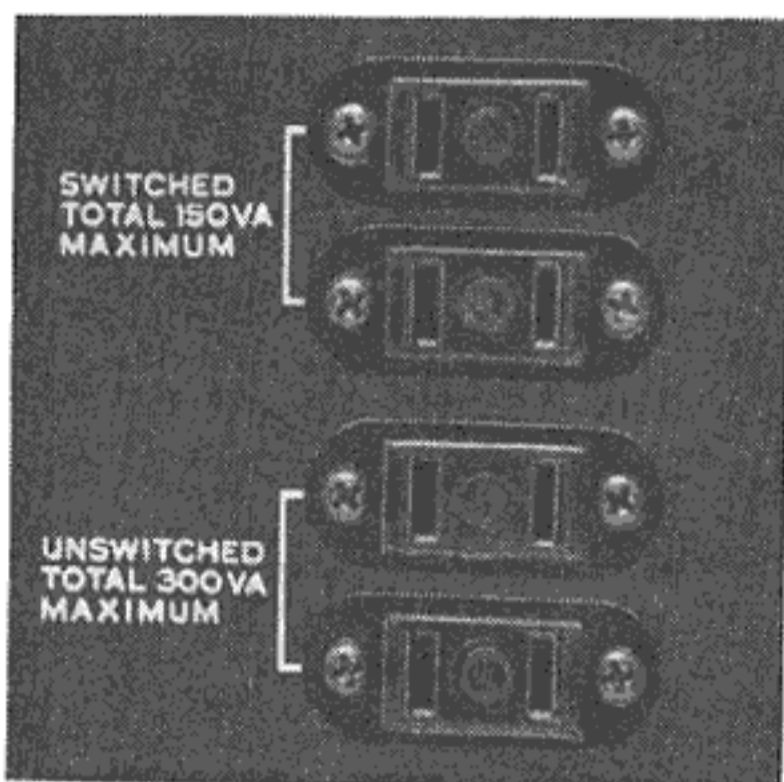

## Power Fuse

**CAUTION:** For the power supply voltage of 100 to 127 volts, use a 4-ampere fuse; for 220 to 250 volts, use a 3-ampere fuse.

If the unit remains completely dead when the power is switched on (POWER indicator fails to light), the power fuse is probably blown. In this case, remove the power plug from its AC outlet and replace the fuse after finding and eliminating the trouble that caused the fuse to blow. (Consult the Troubleshooting Section in your Service Manual)

Use only a glass-tubed 4 (or 3)-ampere fuse. Never attempt to use a piece of wire or a fuse of a different capacity as a substitute.

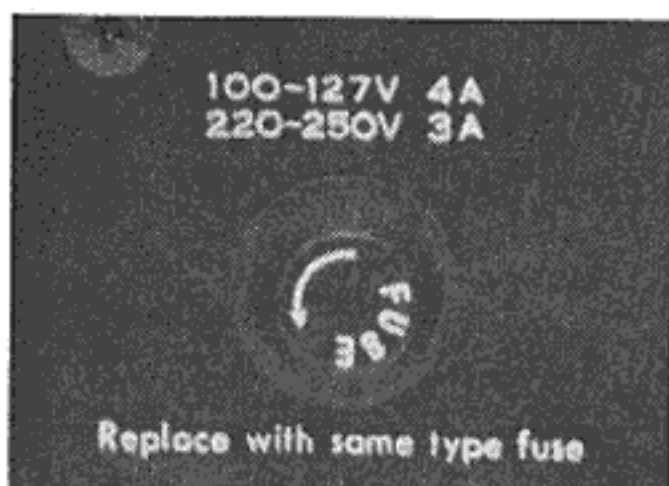

## Voltage Adjustment

To reach the voltage selector, remove the two screws from the nameplate on the rear panel and then remove the nameplate. The voltage selector make it possible to operate the AU-888 at the correct voltage in any area. The voltage has been pre-adjusted at the factory, but can be easily readjusted as follows:

1. Set the arrow of the main voltage selector plug to the required voltage: 100, 110, 117, 127, 220, 230, 240 or 250 volts.
2. If numerals of voltage are printed in red, set the arrow of the adjacent sub V.S. plug to the position marked red. If they are printed in white, set the arrow to the position marked white.
3. It may be necessary to change the power fuse when the AC line voltage is changed. For 100-127 volt operation a 4-ampere fuse is required. For 220-250 volt operation the fuse should be changed to a 3-ampere unit.

**NOTE:** The Voltage Adjustor can be used to eliminate the trouble caused by the considerable voltage fluctuation. In this case, it should be set to the peak voltage.

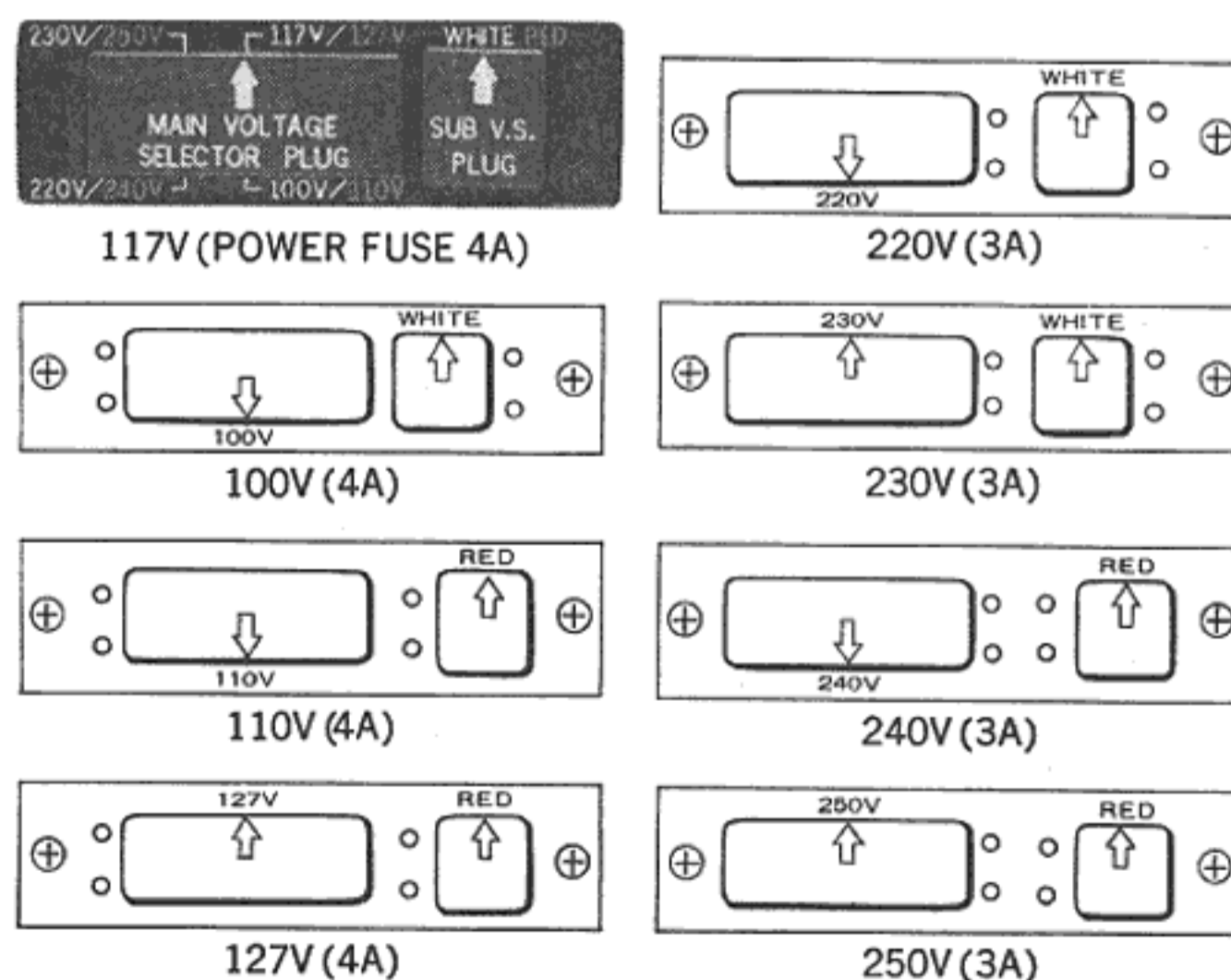

# SPECIFICATIONS

## POWER AMPLIFIER SECTION

### POWER OUTPUT

MUSIC POWER (IHF): 140W at 4 ohms load  
100W at 8 ohms load  
CONTINUOUS POWER: 50/50W at 4 ohms load  
45/45W at 8 ohms load

### TOTAL HARMONIC DISTORTION:

less than 0.4% at rated output

INTERMODULATION: (60Hz : 7,000Hz = 4 : 1 SMPTE method)

less than 0.4% at rated output

### POWER BANDWIDTH (IHF):

10 to 40,000Hz at 8 ohms load

### FREQUENCY RESPONSE: (at normal listening level)

10 to 70,000Hz  $\pm 1$ dB

### CHANNEL SEPARATION: (at 1,000Hz, rated output)

better than 50dB

HUM AND NOISE (IHF): better than 100dB

INPUT SENSITIVITY: 1V for rated output

INPUT IMPEDANCE: 50k ohms

LOAD IMPEDANCE: 4 to 16 ohms

DAMPING FACTOR: 20 at 8 ohms load

## PRE-AMPLIFIER SECTION

### OUTPUT VOLTAGE

MAXIMUM OUTPUT VOLTAGE: 4V

RATED OUTPUT VOLTAGE: 1V

TOTAL HARMONIC DISTORTION: less than 0.1% at rated output voltage

FREQUENCY RESPONSE: 15 to 50,000Hz +0.5dB -1.5dB

### CHANNEL SEPARATION

PHONO: 50dB

AUX: 50dB

### HUM AND NOISE (IHF)

PHONO-1 AND 2: better than 80dB

MIC: better than 80dB

TUNER AND AUX: better than 85dB

### INPUT SENSITIVITY (at 1,000Hz, rated output voltage)

PHONO-1: 2mV (50k ohms)

PHONO-2: 2mV (30k, 50k, 100k ohms)

MIC: 2mV (50k ohms)

TUNER: 180mV (100k ohms)

AUX: 180mV (100k ohms)

TAPE MON (pin): 180mV (100k ohms)

TAPE RECORDER(DIN): 180mV (100k ohms)

### RECORDING OUTPUT

TAPE REC (PIN): 180mV

TAPE RECORDER(DIN): 30mV

## EQUALIZER

PHONO, MIC: NF type

### CONTROLS

BASS: +12dB -8dB at 20Hz (2dB step type)

MIDRANGE: +5dB -5dB at 1,000Hz or 2,000Hz (1dB step type)

TREBLE: +12dB -8dB at 20,000Hz (2dB step type)

### TONE SELECTOR MIDRANGE:

1,000Hz, DEFEAT, 2,000Hz

LOUDNESS: +8dB (50Hz) +3dB (10,000Hz)

### SWITCHES

LOW FILTER: -8dB at 50Hz (12dB/oct, NF type)

HIGH FILTER: -8dB at 10,000Hz (12dB/oct, NF type)

MUTING: -20dB

MODE: STEREO-REV. STEREO-NORM.

MONO-L+R. MONO-L.

MONO-R.

SOURCE SELECTOR: MIC. PHONO-2. PHONO-1.

TUNER. AUX.

TAPE MONITOR: PLAYBACK DECK-1. SOURCE.

PLAYBACK DECK-2.

TAPE TO TAPE REPRINT: DECK-1 to 2. SOURCE RECORD. DECK-2 to 1.

SPEAKER SELECTOR: OFF. SYSTEM-A. SYSTEM-B. SYSTEM-A+B. SYSTEM-C (PRE. and MAIN SEPARATED)

### THE OTHER ACCESSORIES:

5-pin DIN Socket for Tape Recorder, HeadPhones Jack, One-touch clip type Speaker Terminals

### SEMICONDUCTORS

Transistor; 41 Diodes; 12 SCR; 2

### POWER REQUIREMENTS

POWER CONSUMPTION: 400VA (max. signal)

POWER VOLTAGE: 100, 110, 117, 127, 220, 230, 240, 250V 50/60Hz

DIMENSIONS: 460mm(18 $\frac{1}{8}$ " )W, 140mm(5 $\frac{1}{2}$ " )H, 305mm(12" )D

WEIGHT: 12.6kg (27.8 lbs)

\* Manufacturer reserves right to change design and/or specifications without notice for purpose of improvement.

# CHARACTERISTICS / ACCESSORIES

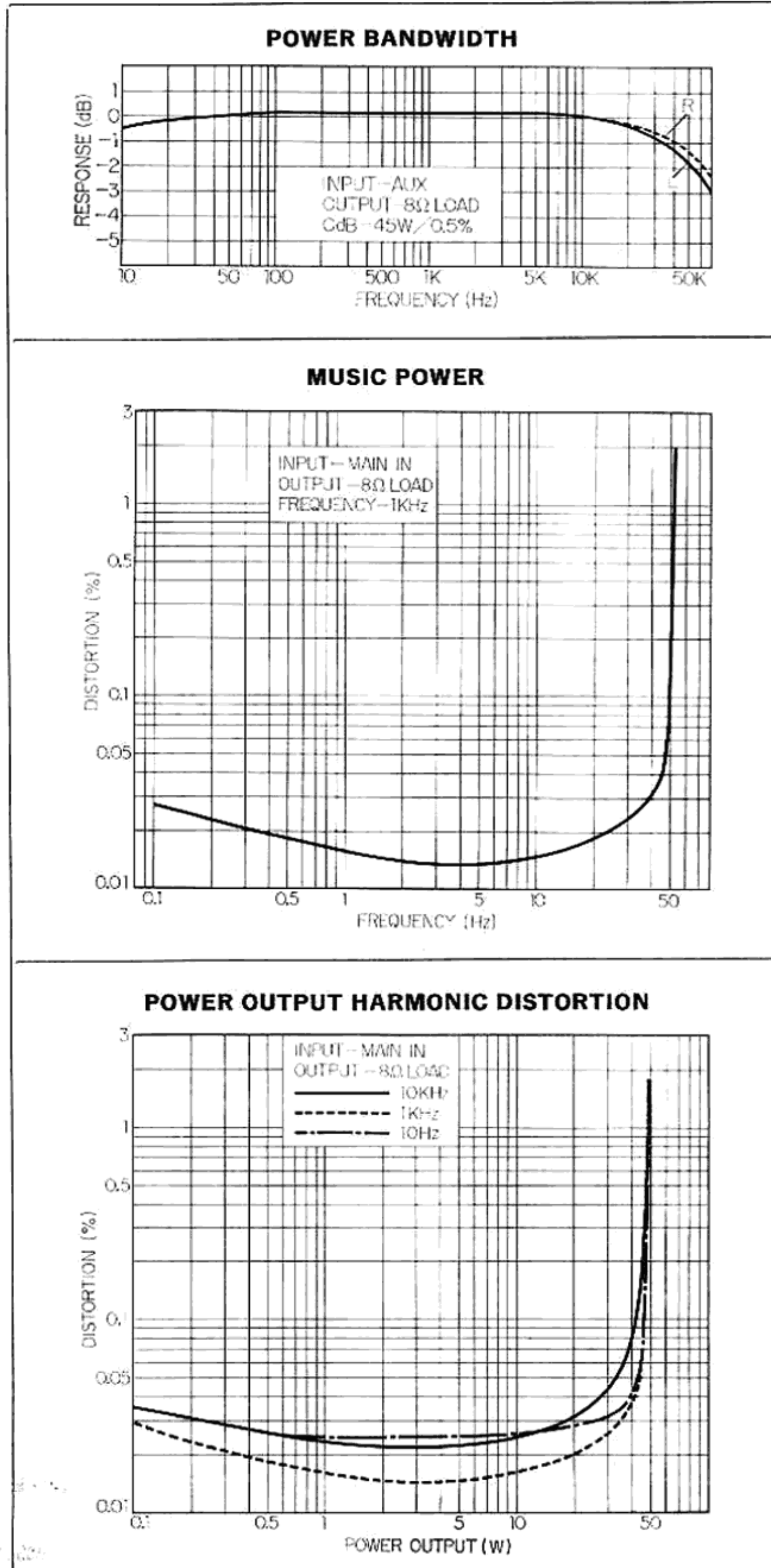

### TRIPLE TONE CONTROL

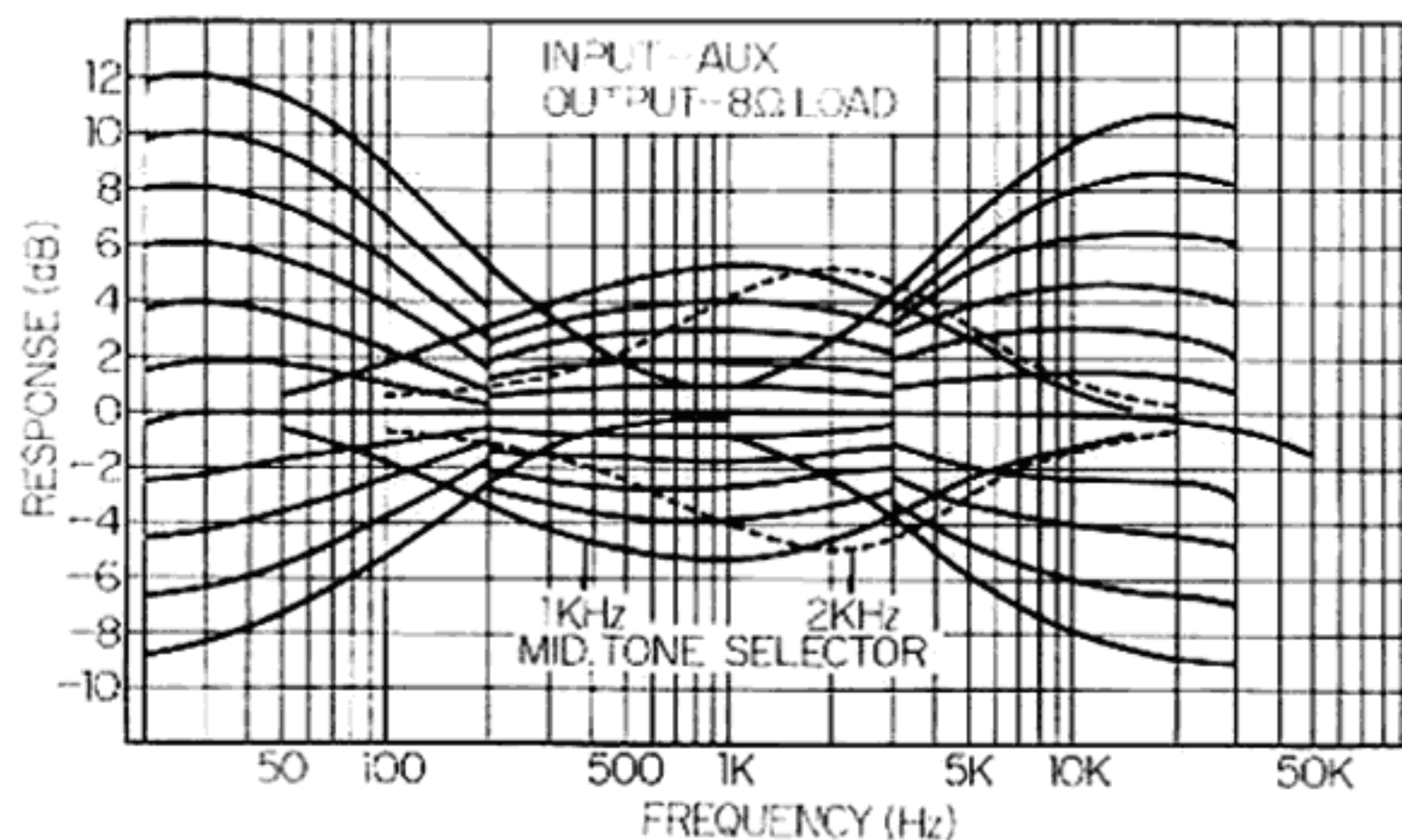

### LOW/HIGH FILTER

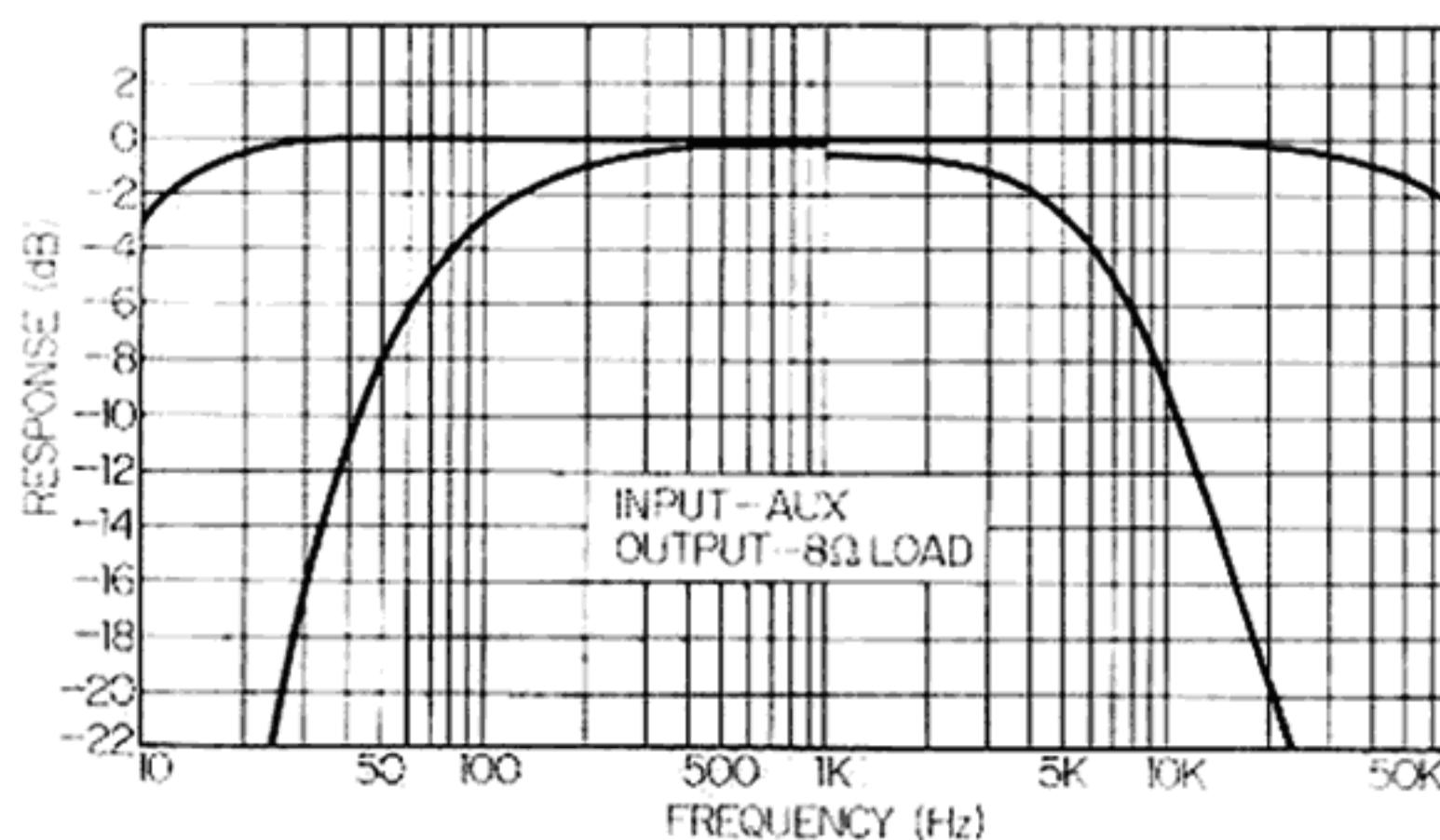

## Accessories List

1. OPERATING INSTRUCTIONS AND SERVICE MANUAL .....	1
2. OPERATING SHEET .....	1
3. PIN-PLUGS .....	4
4. BUTTERFLY BOLTS .....	2
5. WASHERS .....	2
6. POLISHING CLOTH .....	1
7. QUICK ACTING FUSES (SPEAKER FUSES) 4A .....	2

# TROUBLESHOOTING CHART

If the amplifier is otherwise operating satisfactorily, the more common causes of trouble may generally be attributed to the following:

1. Incorrect connections or loose terminal contacts. Check the speakers, record player, tape deck, antenna and line cord.
2. Improper operation. Before operating any audio components, be sure to read the manufacturer's instruc-

tions.

3. Improper location of audio components. The proper positioning of components, such as speakers and turntable, is vital to stereo.

4. Defective audio components.

The following are some other common causes of malfunction and what to do about them.

PROGRAM SOURCE	SYMPTOM	PROBABLE CAUSE	WHAT TO DO
Tuner	Contact or intermittent noise heard at certain times or in a certain area	<ul style="list-style-type: none"> <li>* Discharge or oscillation caused by electrical appliances, such as fluorescent lamp, TV set, D.C. motor, rectifier and oscillator</li> <li>* Natural phenomena, such as atmospheric conditions, static, stray and thunderbolts</li> <li>* Insufficient antenna input due to reinforced concrete walls or long distance from the station</li> <li>* Wave interference from other electrical appliances</li> </ul>	<ul style="list-style-type: none"> <li>* Attach a noise limiter to the electrical appliance that causes the noise, or attach it to the power source of the amplifier.</li> <li>* Install an outdoor antenna and ground the amplifier to raise the signal-to-noise ratio.</li> <li>* Reverse the power cord plug-receptacle connections.</li> <li>* If the noise occurs at a certain frequency, attach a wave trap to the ANT input.</li> <li>* Keep the set at a proper distance from other electrical appliances</li> </ul>
	Noise heard at a particular time of a day, in a certain area or over part of the dial during AM reception	<ul style="list-style-type: none"> <li>* This results from the nature of AM broadcast</li> </ul>	<ul style="list-style-type: none"> <li>* Install the antenna for maximum antenna efficiency.</li> <li>* In some cases, the noise can be eliminated by grounding the amplifier or reversing the power cord plug-receptacle connections.</li> </ul>
	High-frequency noise during AM reception	<ul style="list-style-type: none"> <li>* Adjacent-channel interference or beat interference</li> <li>* TV set too close to the audio system</li> </ul>	<ul style="list-style-type: none"> <li>* Although such noise cannot be eliminated by the amplifier, it is advisable to set the TREBLE control to the minimum counterclockwise position possible and switch on the HIGH FILTER.</li> <li>* Keep the TV set at a proper distance from the audio system.</li> </ul>
	Noise during FM reception	<ul style="list-style-type: none"> <li>* Poor noise limiter effect or too low SN ratio due to insufficient antenna input</li> </ul> <p>Note: FM reception is affected considerably by the broadcasting station's power and antenna efficiency. As a result, you may receive one station quite well while having difficulty in receiving another station</p>	<ul style="list-style-type: none"> <li>* Install the antenna for maximum signal strength.</li> <li>* If this does not prove effective, use an outdoor antenna designed exclusively for FM. When you use a TV antenna for both TV and FM with the help of a splitter make sure the TV reception is not affected.</li> <li>* An excessive long antenna may cause noise.</li> </ul>
	A series of pops	<ul style="list-style-type: none"> <li>* Ignition noise caused by an auto, motorcycle or the like</li> </ul>	<ul style="list-style-type: none"> <li>* Keep the antenna and its lead-in wire away from heavy traveled roads or raise the antenna input.</li> </ul>

PROGRAM SOURCE	SYMPTOM	PROBABLE CAUSE	WHAT TO DO
(continued)	Noise heard during FM stereo, but not heard during FM mono reception	* The service area of the FM stereo broadcast is only half that of the FM mono broadcast.	* Install the antenna for maximum antenna input. * Switch on the HIGH FILTER and/or set the TREBLE control to the minimum counterclockwise position possible.
Record player or tape deck	Hum or howling	* Record player placed directly on the speaker box * Use of wire other than shielded wire * Loose terminal contact * Shielded wire too close to the line cord, fluorescent lamp or other electrical appliances * Nearby amateur radio station or TV transmission antenna	* Put a cushion under the record player. * Experiment with several different arrangements before deciding on the final positions of the speaker and record player. * Use a shielded cord for connections. * Switch on the LOW FILTER. * The connecting cord should be as short as possible. * Don't raise the BASS loudness too much. * Consult the nearest Radio Regulatory Bureau.
	Surface noise	* Worn or old record * Worn pick-up needle * Needle covered with dust * Improper needle pressure	* Set the TREBLE control to the minimum counterclockwise position possible and/or switch on the HIGH FILTER. * Clean or replace the needle.
Common to all program sources	The BALANCE control is not in the mid-position when equal sound comes from both left and right channels.	* Due to imperfections in program material, variations in speaker output or asymmetry in room acoustics, the BALANCE control is not always set to the mid-position.	* Set the MODE switches to MONO and adjust the BALANCE control so that the sound is heard from a point midway between the two speakers.

# DISASSEMBLY PROCEDURE / TEST POINTS

## REMOVING THE FRONT PANEL, WOOD CASE AND BOTTOM PLATE

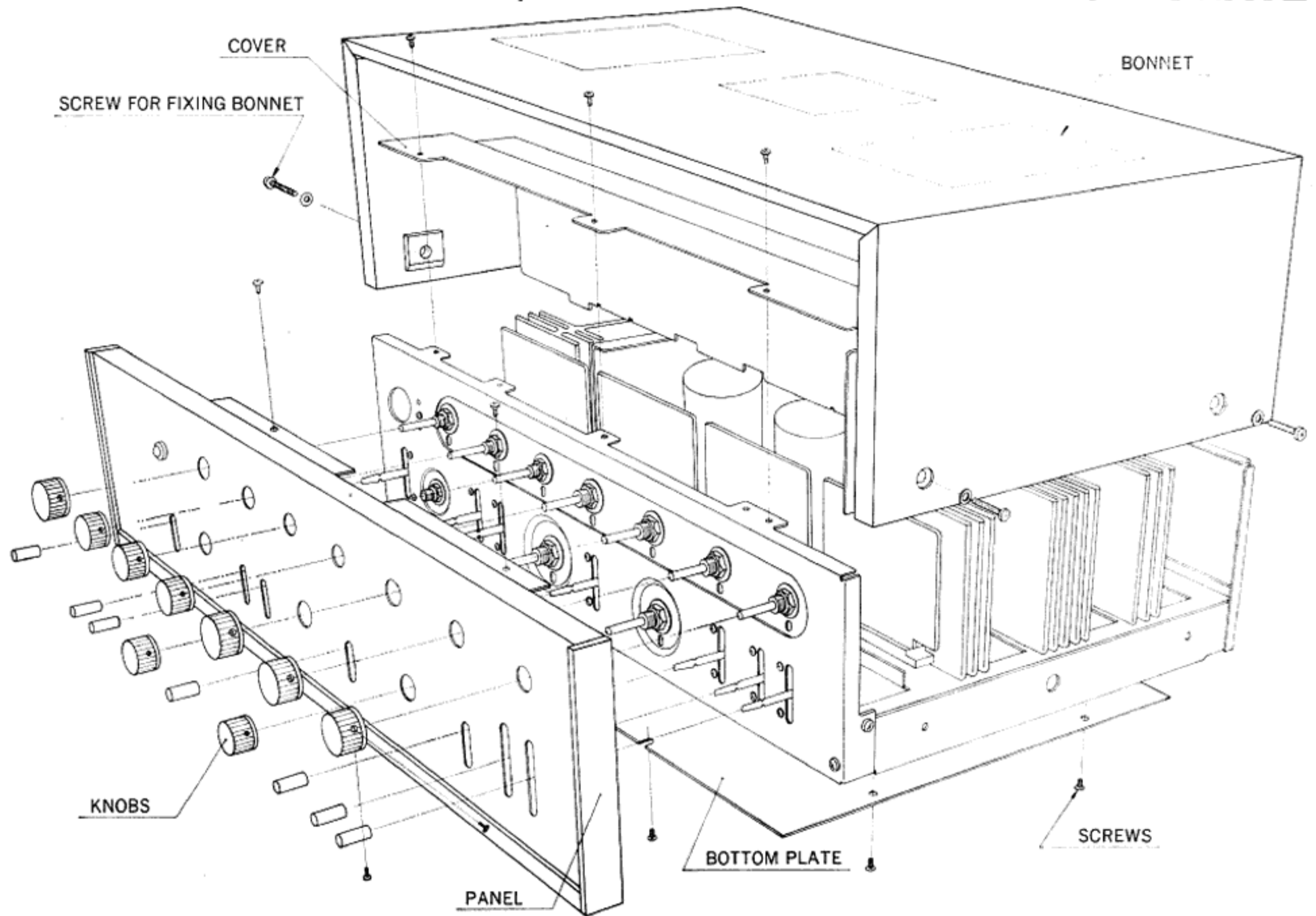

## TEST POINTS

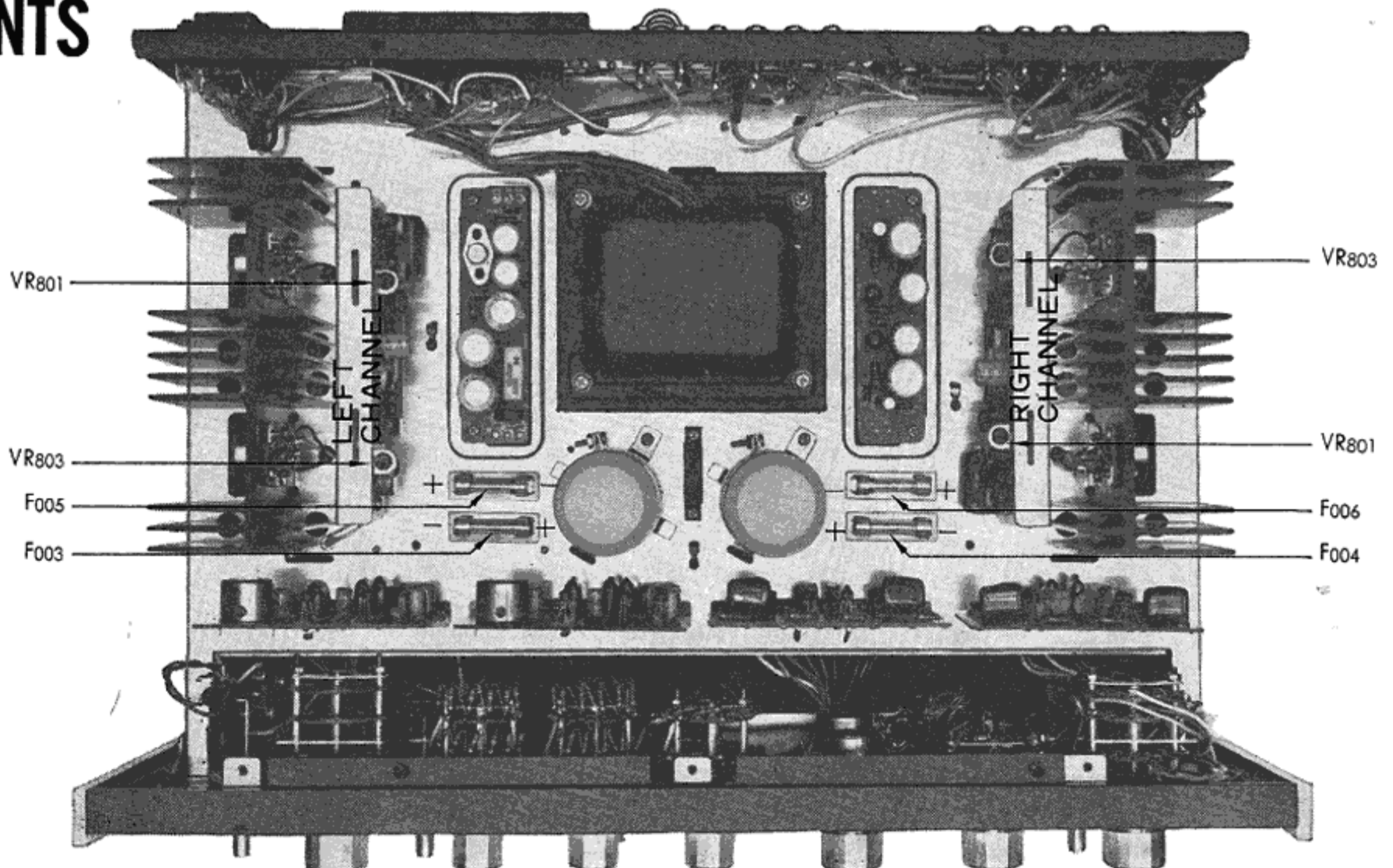



# ALIGNMENT

## MAIN-AMP. SECTION OUTPUT BALANCE ADJUSTMENT

STEP	WHAT TO DO	REMARKS
1.	Connect an 8 to 16-ohm load resistor to the left-channel SYSTEM A speaker terminal.	
2.	Connect a voltmeter in parallel with the load resistor.	The Voltmeter should be used in the 0.5~3V range.
3.	Turn SPEAKERS switch to SYSTEM A.	
4.	Turn POWER switch on.	
5.	Adjust VR <sub>801</sub> (left channel) so that the voltage will be kept within $0 \pm 50\text{mV}$ .  For the right channel, follow the same procedures as above.	

## MAIN-AMP. SECTION CURRENT ADJUSTMENT

STEP	AMMETER (TESTER)	WHAT TO DO	REMARKS
1.		Remove F <sub>003</sub> and F <sub>004</sub> .	
2.		Set VR <sub>803</sub> (left and right channels) to minimum counterclockwise position.	Ammeter required: 100mA or 50mA range
3.		Turn POWER switch ON.	
4.	Set to 100mA range.	Set ammeter in place of F <sub>003</sub> . Connect its $\oplus$ terminal to 2, and its $\ominus$ terminal to B <sub>1</sub> in schematic diagram.	Be sure to turn POWER switch on and then connect ammeter.
5.		Turn VR <sub>803</sub> (left channel) and adjust current to 30mA.	
6.		Turn POWER switch OFF and reset F <sub>003</sub> to its original position.	
7.	Set to 100mA range.	Turn POWER switch ON and set ammeter in place of F <sub>004</sub> . Connect its $\oplus$ terminal to 2, and its $\ominus$ terminal to B <sub>2</sub> .	
8.		Turn VR <sub>803</sub> (right channel) and adjust current to 30mA.	
9.		Turn POWER switch OFF, and attach F <sub>004</sub> .	

# BLOCK DIAGRAM

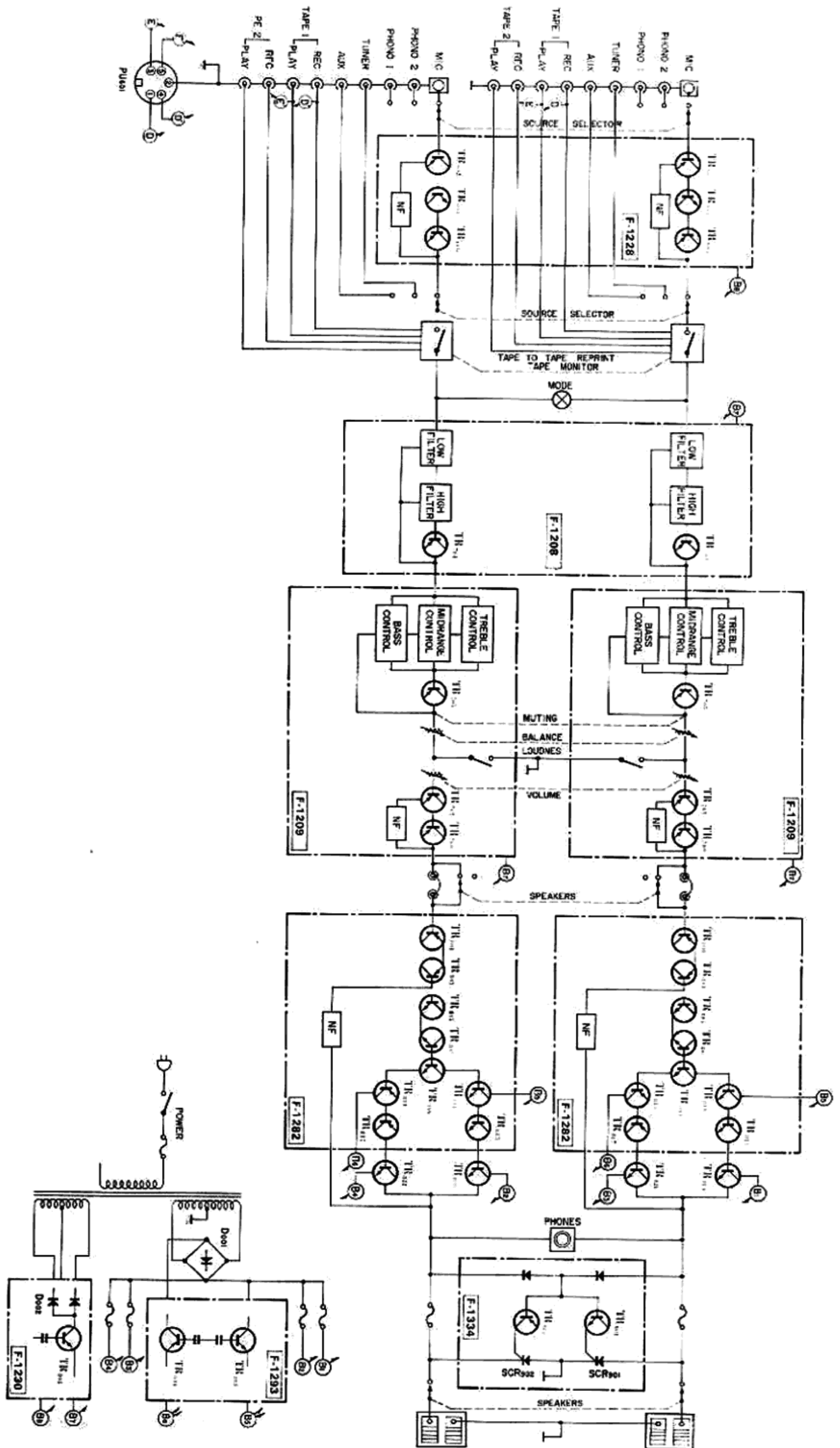

# PRINTED CIRCUIT BOARDS AND PARTS LIST

W: Parts No. X: Parts Name Y: Stock No. Z: Position of Parts

## HEAD AMP. BLOCK <F-1228>

W	X	Y	Z	W	X	Y	Z	
R601	220k $\Omega$	0101224	2 B	R631	33k $\Omega$	±10% ¼W CR.	0101333	2 B
R602	220k $\Omega$	0101224	2 A	R632	33k $\Omega$		0101333	2 A
R603	220k $\Omega$	0101224	1 B	C601	0.47 $\mu$ F	±10% 50V MC.	0601478	1 B
R604	220k $\Omega$	0101224	1 A	C602	0.47 $\mu$ F		0601478	1 A
R605	1k $\Omega$	0101102	2 B	C603	10 $\mu$ F	25V EC.	0513100	2 B
R606	1k $\Omega$	0101102	2 A	C604	10 $\mu$ F		0513100	2 A
R607	1M $\Omega$	0101105	1 B	C605	33pF	±10% 50V CC.	0660330	1 B
R608	1M $\Omega$	0101105	1 A	C606	33pF		0660330	1 A
R609	3.3k $\Omega$	0101332	1 B	C607	47 $\mu$ F	10V EC.	0511470	1 B
R610	3.3k $\Omega$	0101332	1 A	C608	47 $\mu$ F		0511470	1 A
R611	39k $\Omega$	0101393	1 B	C609	33 $\mu$ F	6.3V EC.	0510330	2 B
R612	39k $\Omega$	0101393	1 A	C610	33 $\mu$ F		0510330	2 A
R613	22k $\Omega$	0101223	1 B	C611	470pF	±10% 50V CC.	0660471	2 B
R614	22k $\Omega$	0101223	1 A	C612	470pF		0660471	2 A
R615	47k $\Omega$	0101473	1 B	C613	0.47 $\mu$ F	±10% 50V MC.	0601478	2 B
R616	47k $\Omega$	0101473	1 A	C614	0.47 $\mu$ F		0601478	2 A
R617	3.3k $\Omega$	0101332	1 B	C615	0.006 $\mu$ F	±10% 50V MC.	0601606	2 B
R618	3.3k $\Omega$	0101332	1 A	C616	0.006 $\mu$ F		0601606	2 A
R619	470k $\Omega$	0101474	1 B	C617	0.0022 $\mu$ F	±10% 50V CC.	0601226	2 B
R620	470k $\Omega$	0101474	1 A	C618	0.0022 $\mu$ F		0601226	2 A
R621	180 $\Omega$	0101181	1 B	C619	56pF	±10% 50V CC.	0660560	2 B
R622	180 $\Omega$	0101181	1 A	C620	56pF		0660560	2 A
R623	10k $\Omega$	0101103	2 B	TR601	XA495BL (C)	0300162	1 B	
R624	10k $\Omega$	0101103	2 A	TR602		0300162	1 A	
R625	470 $\Omega$	0101471	2 B	TR603	2SC458LG (B)	0305313	1 B	
R626	470 $\Omega$	0101471	2 A	TR604		0305313	1 A	
R627	39k $\Omega$	0101393	2 B	TR605	XA495BL (B, C, D)	0300161, 2, 3	1 B	
R628	39k $\Omega$	0101393	2 A	TR606		0300161, 2, 3	1 A	
R629	33k $\Omega$	0101333	2 B					
R630	33k $\Omega$	0101333	2 A					

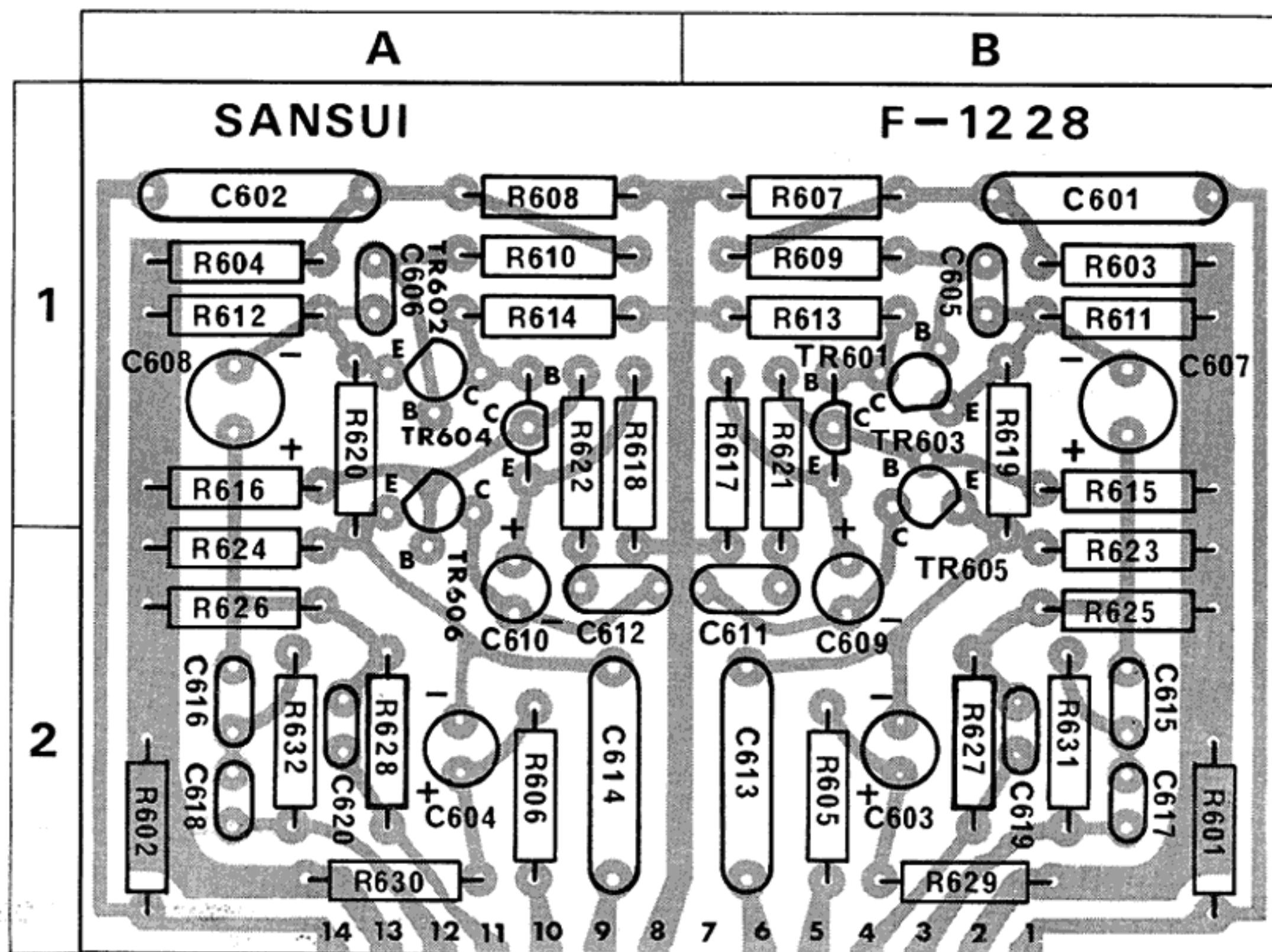

# PRINTED CIRCUIT BOARDS AND PARTS LIST

W: Parts No. X: Parts Name Y: Stock No. Z: Position of Parts

## FILTER BLOCK <F-1208A>

W	X	Y	Z
R711	1MΩ	0101105	2 B
R712	1MΩ	0101105	2 A
R713	39kΩ	0101393	2 B
R714	39kΩ	0101393	2 A
R715	100kΩ	0101104	2 B
R716	100kΩ	0101104	2 A
R717	6.8kΩ	0101682	2 B
R718	6.8kΩ	0101682	2 A
R719	15kΩ	0101153	1 B
R720	15kΩ	0101153	1 A
R721	470kΩ	0101474	1 B
R722	470kΩ	0101474	1 A
R725	1MΩ	0101105	1 B
R726	1MΩ	0101105	1 A
R727	8.2kΩ	0101822	1 B
R728	8.2kΩ	0101822	1 A
R729	470Ω	0101471	1 B
R730	470Ω	0101471	1 A

±10% ¼W CR.

W	X	Y	Z
C705	0.08μF	0601807	2 B
C706	0.08μF	0601807	2 A
C707	0.033μF	0601337	2 B
C708	0.033μF	0601337	2 A
C709	0.0022μF	0601226	2 B
C710	0.0022μF	0601226	2 A
C711	0.47μF	0601478	1 B
C712	0.47μF	0601478	1 A
C713	0.001μF	0601106	2 B
C714	0.001μF	0601106	2 A
C715	0.047μF	0601477	2 B
C716	0.047μF	0601477	2 A
C717	10μF	0513100	2 B
C718	10μF	0513100	2 A
C755	470pF	0660471	
C756	470pF	0660471	
TR703	XA495BL (B, C, D)	0300161, 2, 3	1 B
TR704		0300161, 2, 3	1 A

±10% 50V MC.

25V EC.

±10% 50V CC.

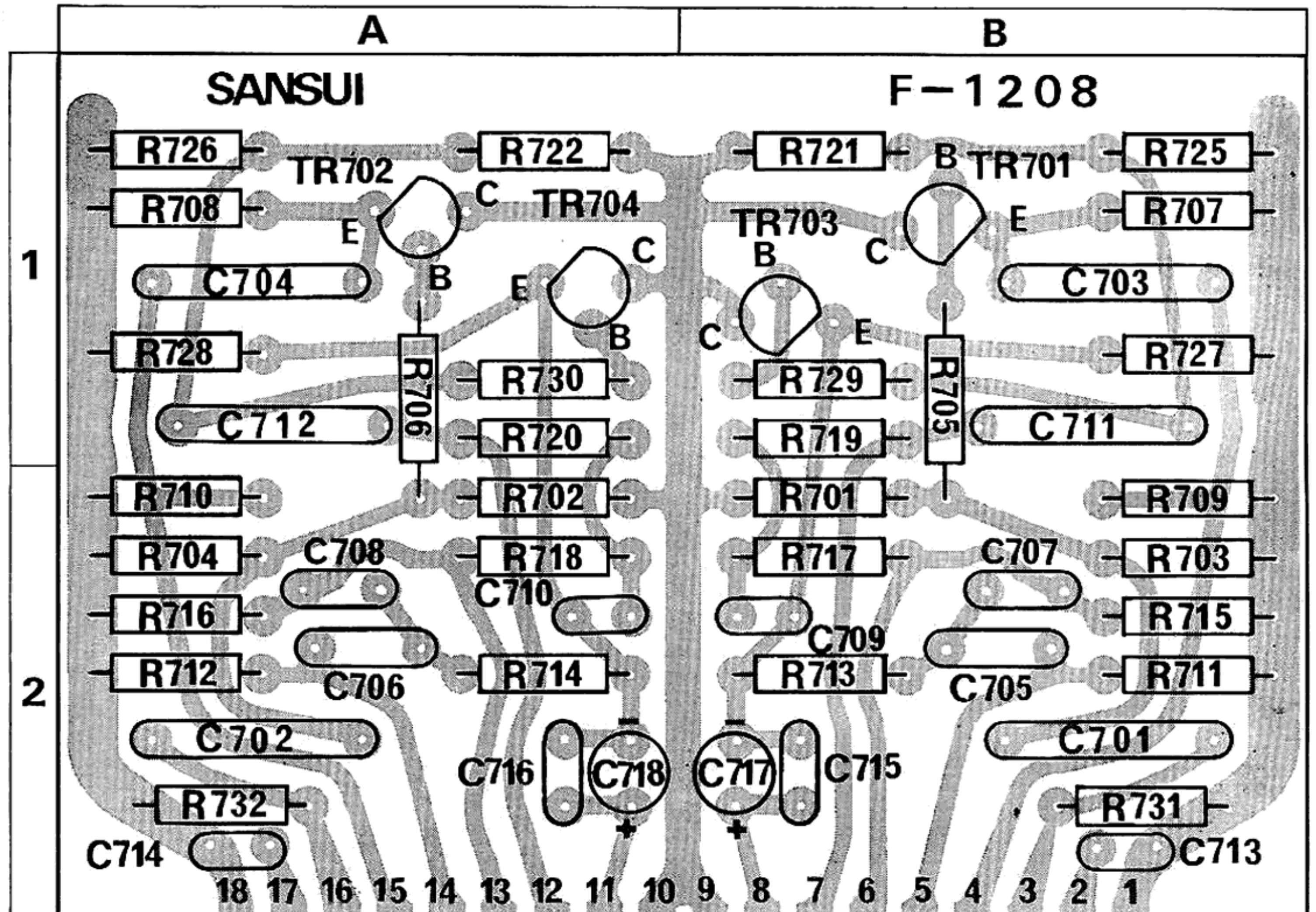

CR: Carbon Resistor  
 SR: Solid Resistor  
 CeR: Cement Resistor  
 BPEC: BP Electrolytic Capacitor  
 MC: Mylar Capacitor

EC: Electrolytic Capacitor  
 MIC: Mica Capacitor  
 OC: Oil Capacitor  
 CC: Ceramic Capacitor  
 MFR: Metal Film Capacitor

### tone control block <F-1209A>

W	X	Y	Z
R735	1MΩ	0101105	2 A
R737	10kΩ	0101103	2 B
R739	6.8kΩ	0101682	2 B
R741	8.2kΩ	0101822	2 B
R743	2.2kΩ	0101222	2 B
R745	10kΩ	0101103	2 B
R747	10kΩ	0101103	2 B
R749	8.2kΩ	0101822	2 A
R751	8.2kΩ	0101822	2 A
R753	18kΩ	0101183	2 B
R755	470kΩ	0101474	1 B
R757	330kΩ	0101334	1 B
R759	5.6kΩ	0101562	1 A
R761	3.3kΩ	0101332	1 B
R763	4.7kΩ	0101472	1 A
R765	100kΩ	0101104	1 A
R767	47kΩ	0101473	1 A
R769	1.5kΩ	0101152	2 A
R771	5.6kΩ	0101562	1 A
R773	820Ω	0101821	2 A

W	X	Y	Z
R775	8.2kΩ ±10% ¼W CR.	0101822	1 A
C719	10µF 25V EC.	0513100	1 A
C721	0.47µF ±10% 50V MC.	0601478	1, 2 B
C723	47µF 10V EC.	0511470	1 B
C725	0.47µF ±10% 50V MC.	0601478	2 A
C727	0.47µF ±10% 50V MC.	0601478	2 A
C729	33µF 25V EC.	0513330	2 A
C731	33pF ±10% 50V CC.	0660330	1 A
C733	47µF 10V EC.	0511470	2 A
C735	10µF 25V EC.	0513100	1 A
C737	0.1µF ±10% 50V MC.	0601108	1 A
C753	22pF ±10% 50V CC.	0660220	1 A
C755	3.3µF 50V EC.	0515339	2 A
TR705	XA495BL (B, C, D)	0300161, 2, 3	1 B
TR707		0300161, 2, 3	1 A
TR709		0300161	1 A
L701	0.8H Choke Coil	4010030	1 B

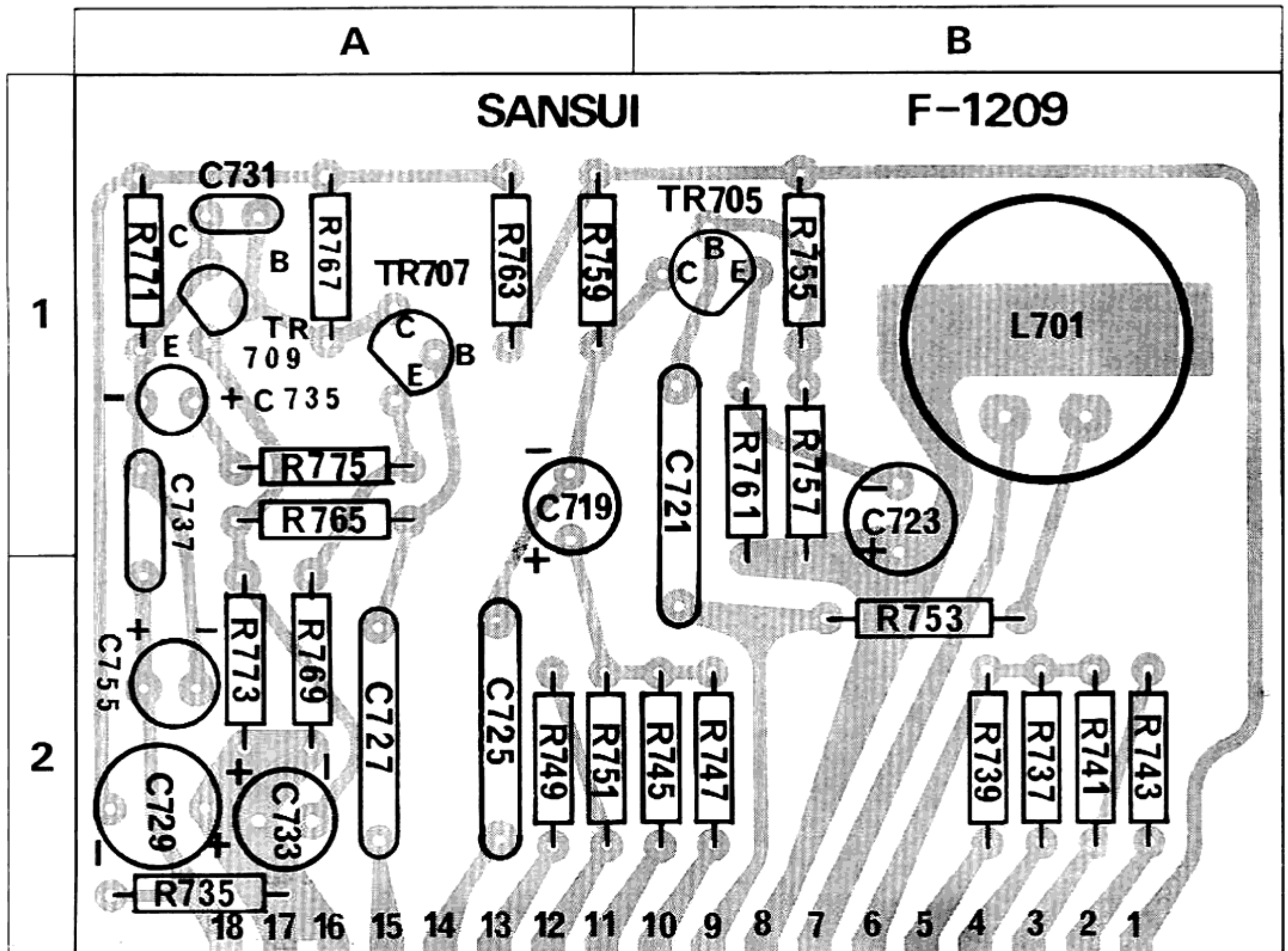

# PRINTED CIRCUIT BOARDS AND PARTS LIST

W: Parts No. X: Parts Name Y: Stock No. Z: Position of Parts

## DRIVER BLOCK <F-1282-1>

W	X	Y	Z
R801	470kΩ	0101474	2 B
R803	10kΩ	0101103	2 B
R805	47kΩ	0101473	1 B
R807	3.9kΩ	0101392	1 B
R809	3.9kΩ	0101392	2 B
R811	82Ω	0101820	1 B
R813	82Ω	0101820	1 B
R815	82Ω	0101820	2 B
R817	2.2kΩ	0101222	1 B
R819	47kΩ	0101473	1 B
R821	82Ω	0101820	2 B
R823	82Ω	0101820	2 B
R825	220Ω	0101221	2 B
R827	8.2kΩ	0101822	1 A
R829	680Ω	0101681	1 A
R831	47Ω	0101470	1 A
R833	3.3kΩ	0101332	1 A
R835	680Ω	0101681	1 A
R837	120Ω	0101121	1 B
R839	1kΩ	0101102	1 A
R841	6.8Ω	0111689	2 A
R843	6.8Ω	0111689	2 A
R845	18kΩ	0101183	1 B
R847	22Ω	0111220	2 A
R849	220Ω	0111221	2 A
R851	220Ω	0111221	1, 2 A

W	X	Y	Z
R857	10Ω ±10% 2W MFR.	0172100	2 B
R861	18kΩ	0101183	1 B
R863	18kΩ ±10% ¼W CR.	0101183	1 B
C801	1μF ±10% 50V MC.	0601109	2 B
C803	100pF	0660101	2 B
C805	0.001μF ±10% 50V CC.	0660102	1, 2 B
C807	22μF ±30% 10V BPEC.	0531220	1 B
C809	100μF 25V EC.	0513101	1 B
C811	100pF	0660101	2 B
C813	10pF	0660100	1 B
C819	0.1μF ±10% 50V MC.	0601108	2 B
TR801	XA495G (C, D)	0300172, 3	1 B
TR803		0300172, 3	1 B
TR805	CDC8002-1 (A, B, C)	0305550, 1, 2	2 B
TR807		0305550, 1, 2	2 B
TR809	2SC984 (C)	0305872	1 A
TR811	CDC8002-1 (A, B, C)	0305550, 1, 2	1 A
TR813	CDC9002-1 (A, B, C)	0300140, 1, 2	1 A
TR815	2SC680 Blue (B, C)	0305621, 2	2 A
TR817	2SA566 (B, C)	0300151, 2	2 A
D801	SR1FM-2	0310870	1 B
D803		0310870	1 B
VR801	5kΩ (B)	1033091	1 B
VR803	1kΩ (B)	1033051	1 A

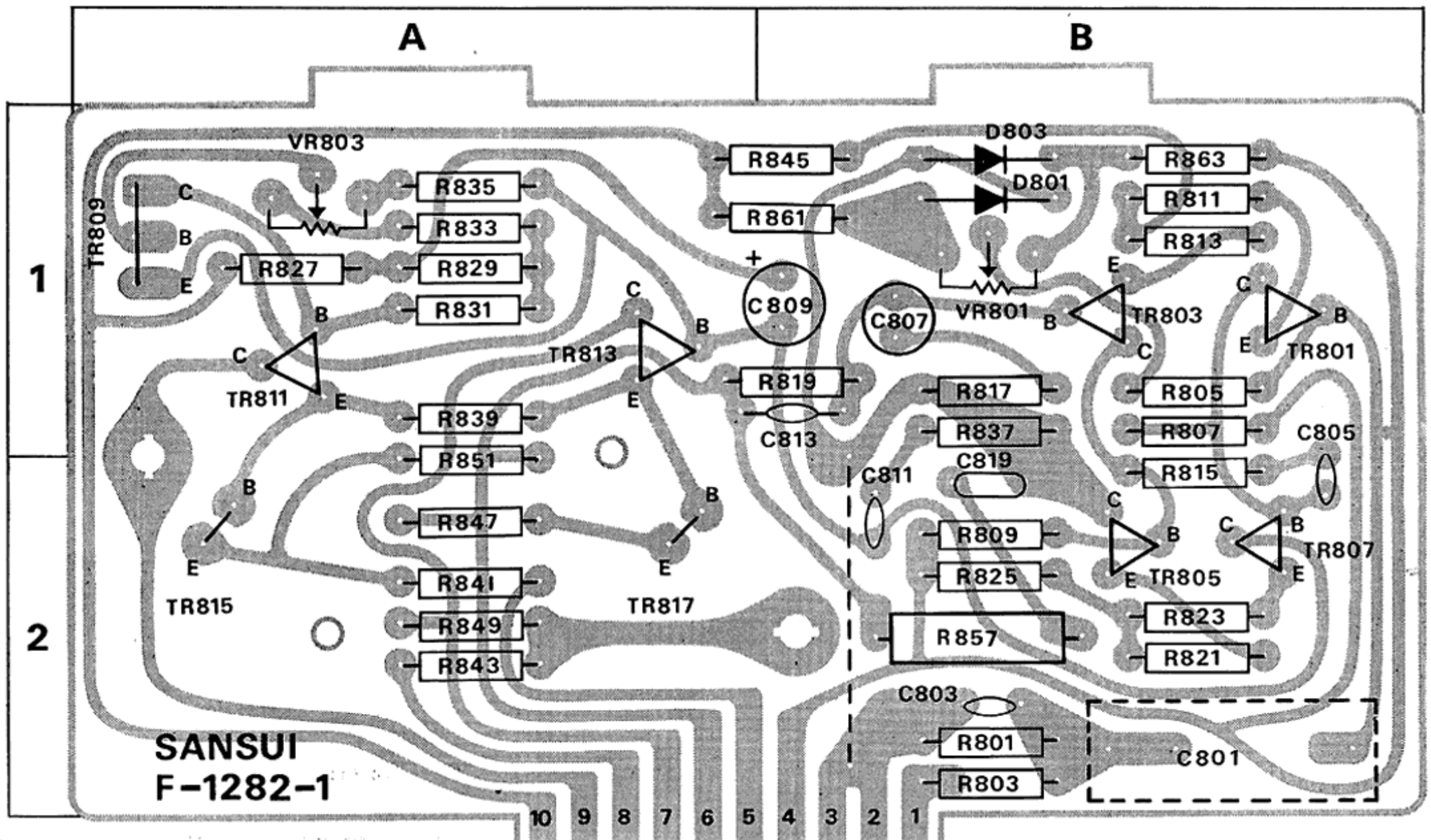

# POWER BLOCK <F-1293>

W	X	Y	Z
R011	10kΩ	0111103	B
R012	4.7kΩ	0111472	A
R013	47Ω	0111470	B
R014	47Ω	0111470	A
$\pm 10\% \frac{1}{2}W$ SR.			
C021	1000μF	0511102	B
C022	1000μF	0511102	A
C023	100μF	0515101	B
C024	100μF	0515101	A
C025	4.7μF	0515479	B
C026	4.7μF	0515479	A
C027	0.01μF	0660103	B
C028	0.01μF	0660103	A
$\pm 10\%$ 50V CC.			
TR003	CDC8002-1 (A)	0305550	B
TR004	CDC9002-1 (A)	0300140	A
D003	SR1FM-2	0310870	B
D004		0310870	A

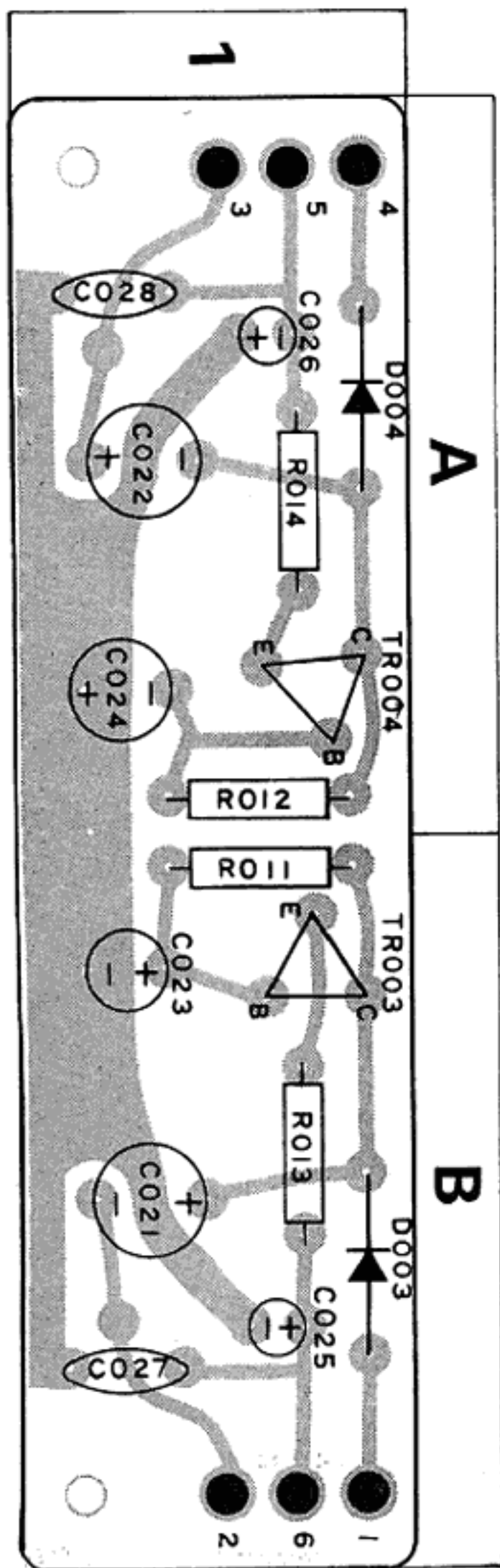

# RIPPLE FILTER BLOCK <1230A>

W	X	Y	Z
R003	68Ω	0153680	B
R004	33kΩ	0111333	A
R005	8.2kΩ	0111822	A
R006	820Ω	0111821	A
$\pm 10\% \frac{1}{2}W$ SR.			
C006	220μF	0515221	B
C007	100μF	0515101	A
C008	100μF	0515101	A
C009	100μF	0515101	A
C010	220μF	0515221	B
C011	0.01μF	0660103	A
$\pm 10\%$ 50V CC.			
TR001	2SD223 (Y, G)	0308231, 2	A
D002	10DC-1R	0310670	B

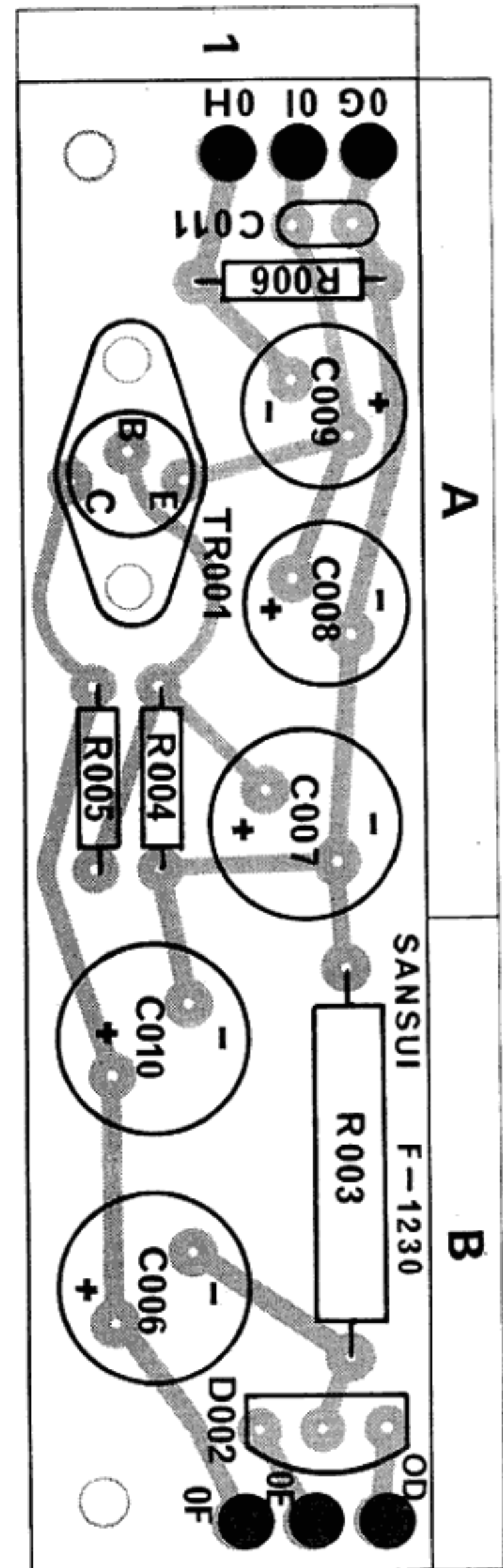

# PRINTED CIRCUIT BOARDS AND PARTS LIST

W: Parts No. X: Parts Name Y: Stock No. Z: Position of Parts

## SP PROTECTOR BLOCK <F-1334>

W	X	Y	Z
R901	10kΩ	0101103	B
R902	10kΩ	0101103	A
R903	3.9kΩ	0101392	B
R904	3.9kΩ	0101392	A
R905	560Ω	0101561	B
R906	470Ω	0101471	A
R907	150Ω	0101151	B
R908	120Ω	0101121	A
R910	150Ω	0101151	A
C901	0.02μF	0659005	B
C902	0.02μF	0659005	A
C903	220μF	0531221	A, B
TR901	CDC8002-1 (B, C)	0305551, 2	B
TR902	CDC9002-1 (B, C)	0300141, 2	A
D901	10DC-1R	0310670	B
D902	10DC-1N	0310680	A
D903	SR1FM-2	0310870	B
D904		0310870	A
SCR901	1RC5	0350050	B
SCR902		0350050	A

## CR BLOCK <F-1300>

W	X	Y	Z
R7159	2.2kΩ	0101222	A
R7160	2.2kΩ	0101222	B
R7161	8.2kΩ	0101822	A
R7162	8.2kΩ	0101822	B
C745	0.0022μF	0601226	A
C746	0.0022μF	0601226	B
C747	0.047μF	0601477	A
C748	0.047μF	0601477	B
C751	0.047μF	0601477	A, B
C752	0.047μF	0601477	B

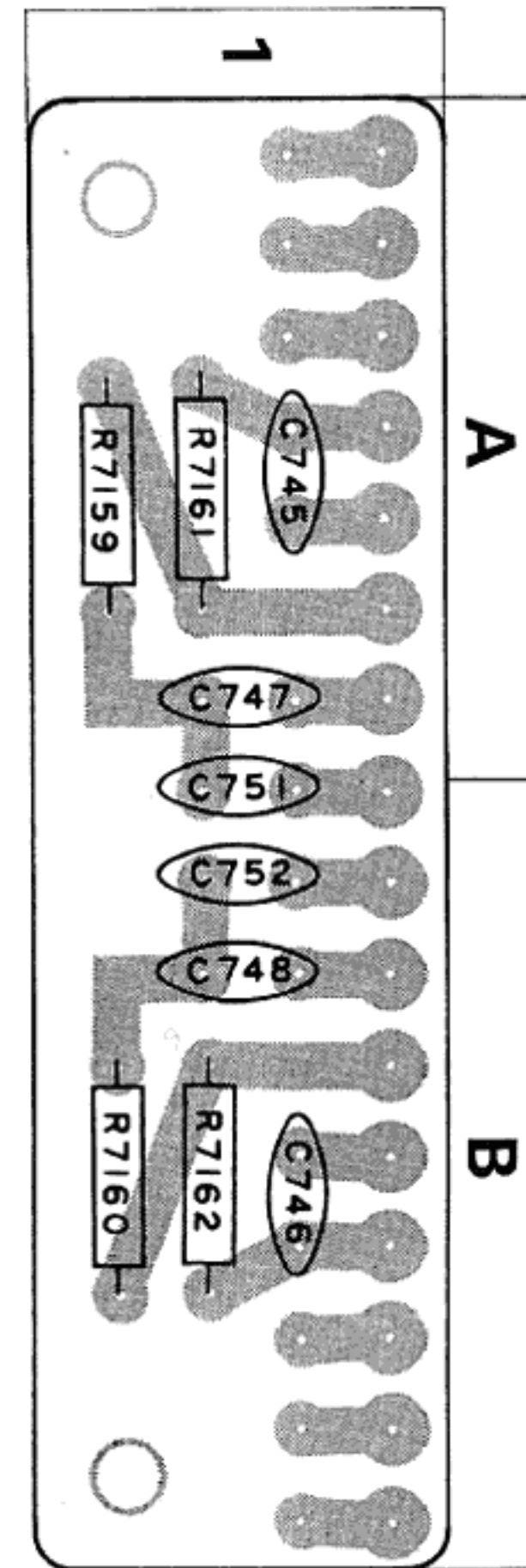
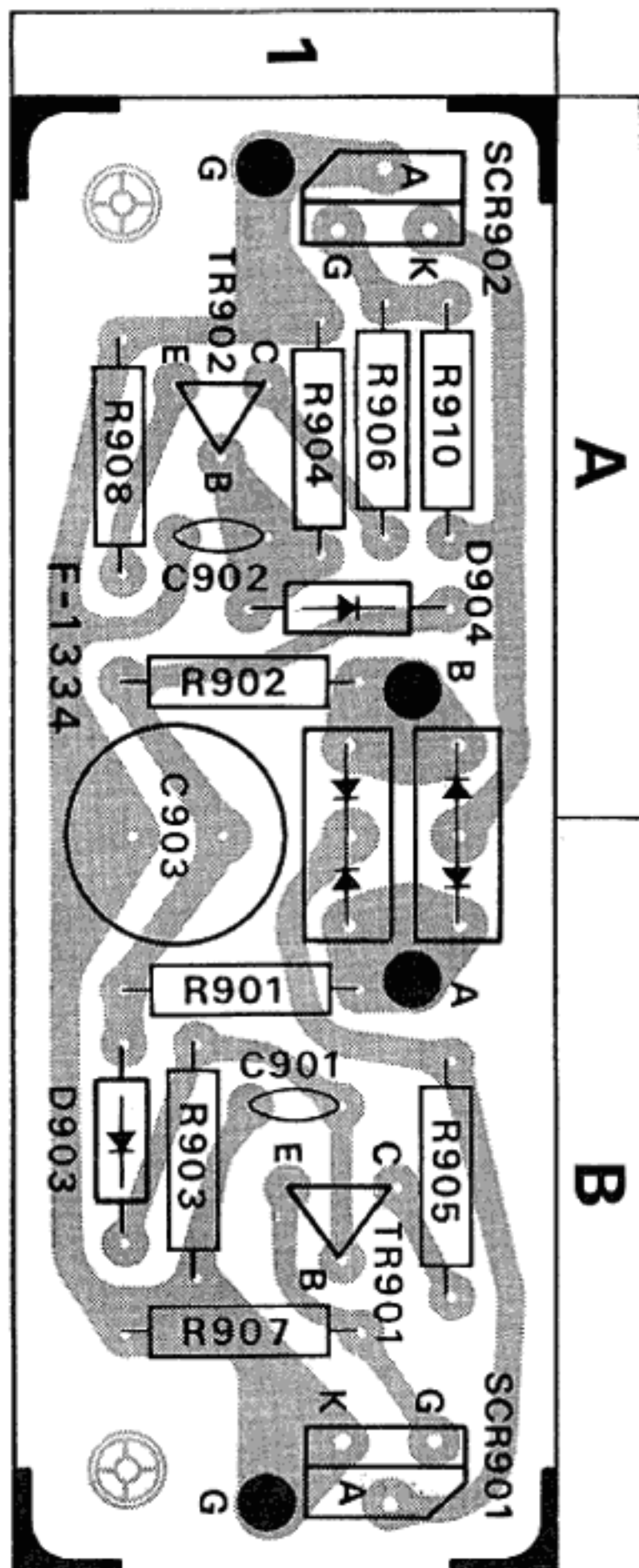



# OTHER PARTS AND THEIR POSITION ON CHASSIS

W	X	Y	W	X	Y
R635	100kΩ	0101104	R7120	6.8kΩ	0100682
R636	100kΩ	0101104	R7121	5.6kΩ	0100562
R637	100kΩ	0101104	R7122	5.6kΩ	0100562
R638	100kΩ	0101104	R7123	3.9kΩ	0100392
R639	100kΩ	0101104	R7124	3.9kΩ	0100392
R640	100kΩ	0101104	R7125	3.3kΩ	0100332
R641	100kΩ	0101104	R7126	3.3kΩ	0100332
R642	100kΩ	0101104	R7127	3.3kΩ	0100332
R643	47kΩ	0101473	R7128	3.3kΩ	0100332
R644	47kΩ	0101473	R7129	3.9kΩ	0100392
R645	56kΩ	0101563	R7130	3.9kΩ	0100392
R646	56kΩ	0101563	R7131	3.9kΩ	0100392
R647	100kΩ	0101104	R7132	3.9kΩ	0100392
R648	100kΩ	0101104	R7133	3.9kΩ	0100392
R649	330kΩ	0101334	R7134	3.9kΩ	0100392
R650	330kΩ	0101334	R7135	3.9kΩ	0100392
R651	100Ω	0101101	R7136	3.9kΩ	0100392
R652	100Ω	0101101	R7137	3.9kΩ	0100392
R713	820kΩ	0101824	R7138	3.9kΩ	0100392
R714	820kΩ	0101824	R7139	3.9kΩ	0100392
R715	820kΩ	0101824	R7140	3.9kΩ	0100392
R716	820kΩ	0101824	R7141	3.3kΩ	0100332
R723	3.3kΩ	0101332	R7142	3.3kΩ	0100332
R724	3.3kΩ	0101332	R7143	2.7kΩ	0100272
R733	820kΩ	0101824	R7144	2.7kΩ	0100272
R734	820kΩ	0101824	R7145	2.7kΩ	0100272
R777	6.8kΩ	0100682	R7146	2.7kΩ	0100272
R778	6.8kΩ	0100682	R7147	8.2kΩ	0101822
R779	8.2kΩ	0100822	R7148	8.2kΩ	0101822
R780	8.2kΩ	0100822	R7149	820kΩ	0101824
R781	10kΩ	0100103	R7150	820kΩ	0101824
R782	10kΩ	0100103	R7159	27kΩ	0101273
R783	10kΩ	0100103	R7160	27kΩ	0101273
R784	10kΩ	0100103	R7163	470kΩ	0101474
R785	12kΩ	0100123	R7164	470kΩ	0101474
R786	12kΩ	0100123	R853	0.5Ω	0153508
R787	12kΩ	0100123	R854	0.5Ω	0153508
R788	12kΩ	0100123	R855	0.5Ω	0153508
R789	10kΩ	0100103	R856	0.5Ω	0153508
R790	10kΩ	0100103	R859	470Ω	0172471
R791	10kΩ	0100103	R860	470Ω	0172471
R792	10kΩ	0100103	C001	0.0047μF	0591476
R793	8.2kΩ	0100822	C002	4700μF	0559311
R794	8.2kΩ	0100822	C003	4700μF	0559311
R795	6.8kΩ	0100682	C004	0.1μF	0590108
R796	6.8kΩ	0100682	C739	0.022μF	0601227
R797	4.7kΩ	0100472	C740	0.022μF	0601227
R798	4.7kΩ	0100472	C741	0.01μF	0601107
R799	6.8kΩ	0100682	C742	0.01μF	0601107
R7110	6.8kΩ	0100682	C765	0.03μF	0601307
R7111	8.2kΩ	0100822	C766	0.03μF	0601307
R7112	8.2kΩ	0100822	C767	150pF	0641151
R7113	12kΩ	0100123	C768	150pF	0641151
R7114	12kΩ	0100123	CR001	0.047μF × 4	0800121
R7115	10kΩ	0100103	TR819		0305830, 1,2
R7116	10kΩ	0100103	TR820		0305830, 1,2
R7117	10kΩ	0100103	TR821		0305830, 1,2
R7118	10kΩ	0100103	TR822		0305830, 1,2
R7119	6.8kΩ	0100682			

# OTHER PARTS AND THEIR POSITION ON CHASSIS

W: Parts No. X: Parts Name Y: Stock No.

W	X	Y
D001	5B2	0310660
VR701, 702	250kΩ (MN) Balance Control	1010570, 1010571
VR703, 704	250kΩ (B) × 2 Volume Control	1010580, 1010581
S1(a~g)	Source Selector Switch	Y-3-6-5 1103311
S2(a~d)	Tape to Tape Reprint Switch	1170140
S3(a, b)	Tape Monitor Switch	1170130
S4(a, b)	Pick Up Load Switch	1110110
S5(a~c)	Mode Switch	Y-1-2-5 1101190
S6(a, b)	Low Filter Switch	1170120
S7(a, b)	High Filter Switch	1170120
S8(a, b)	Midrange Switch	F-2-2-11 1102120
S9(a, b)	Midrange Selector Switch	1101200
S10(a, b)	Treble Switch	F-2-2-11 1102120
S11(a, b)	Bass Switch	F-2-2-11 1102120
S12(a, b)	Muting Switch	1170120
S13(a, b)	Loudness Switch	1170120
S14(a~f)	Speaker Switch	Y-3-8-5 1103251

W	X	Y
S15	Power Switch	1170200
T001	Power Transformer 400-5438	4000790
J601	MIC Jack	2430071
J602		2430071
J801	Headphones Jack	2430071
PU001	Voltage Selector Socket	2410170
PU002, 003	Voltage Selector Plug	2410180 2410190
PU601	DIN Connector	2430040
CO001~004	AC Outlet	2450010
PL001	Power Indicator	0400090
F001~006	4A Quick Acting Fuse	0430392
F007	4A Fuse (100~127V)	0430052
	3A Fuse (220~250V)	0430042

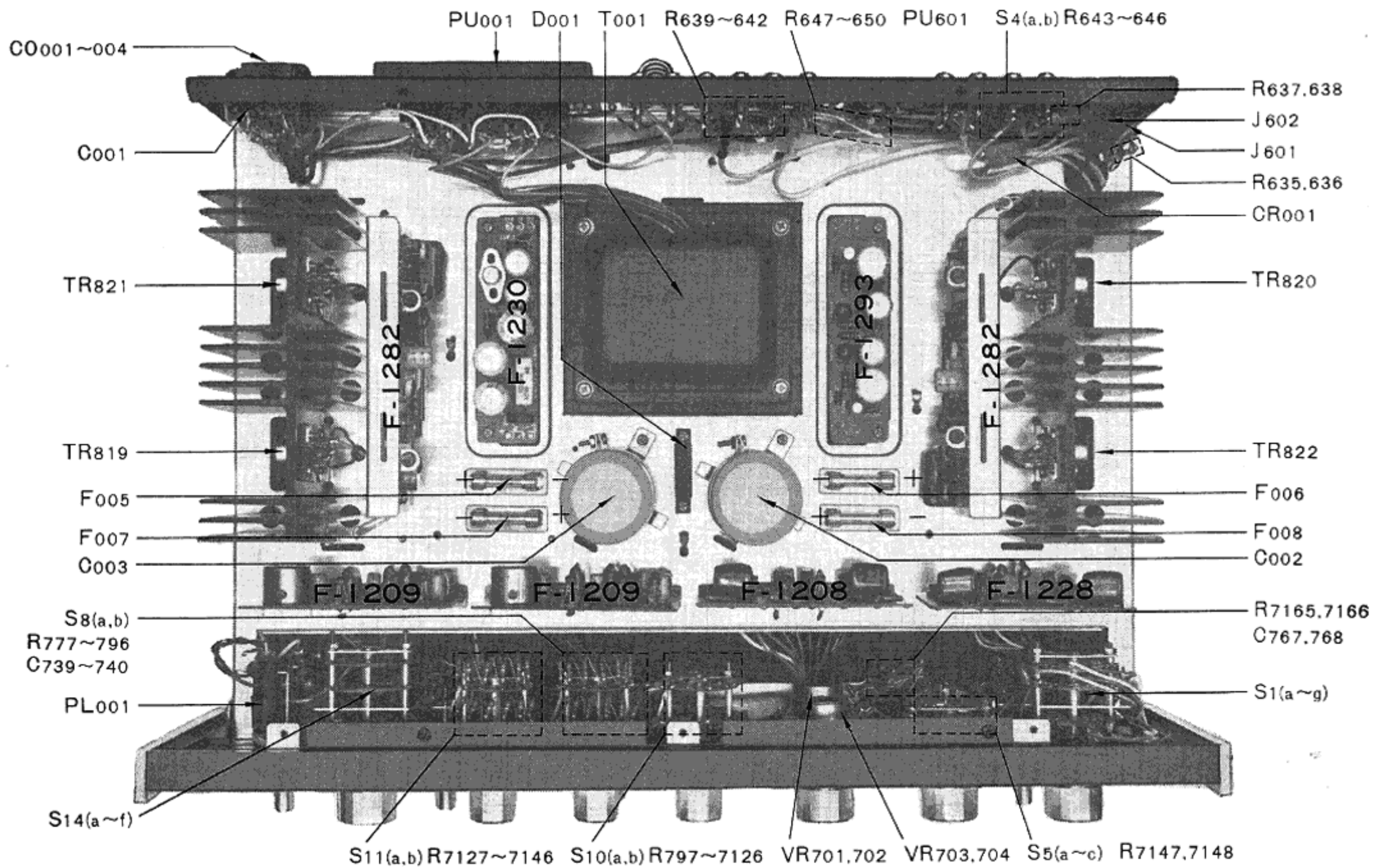

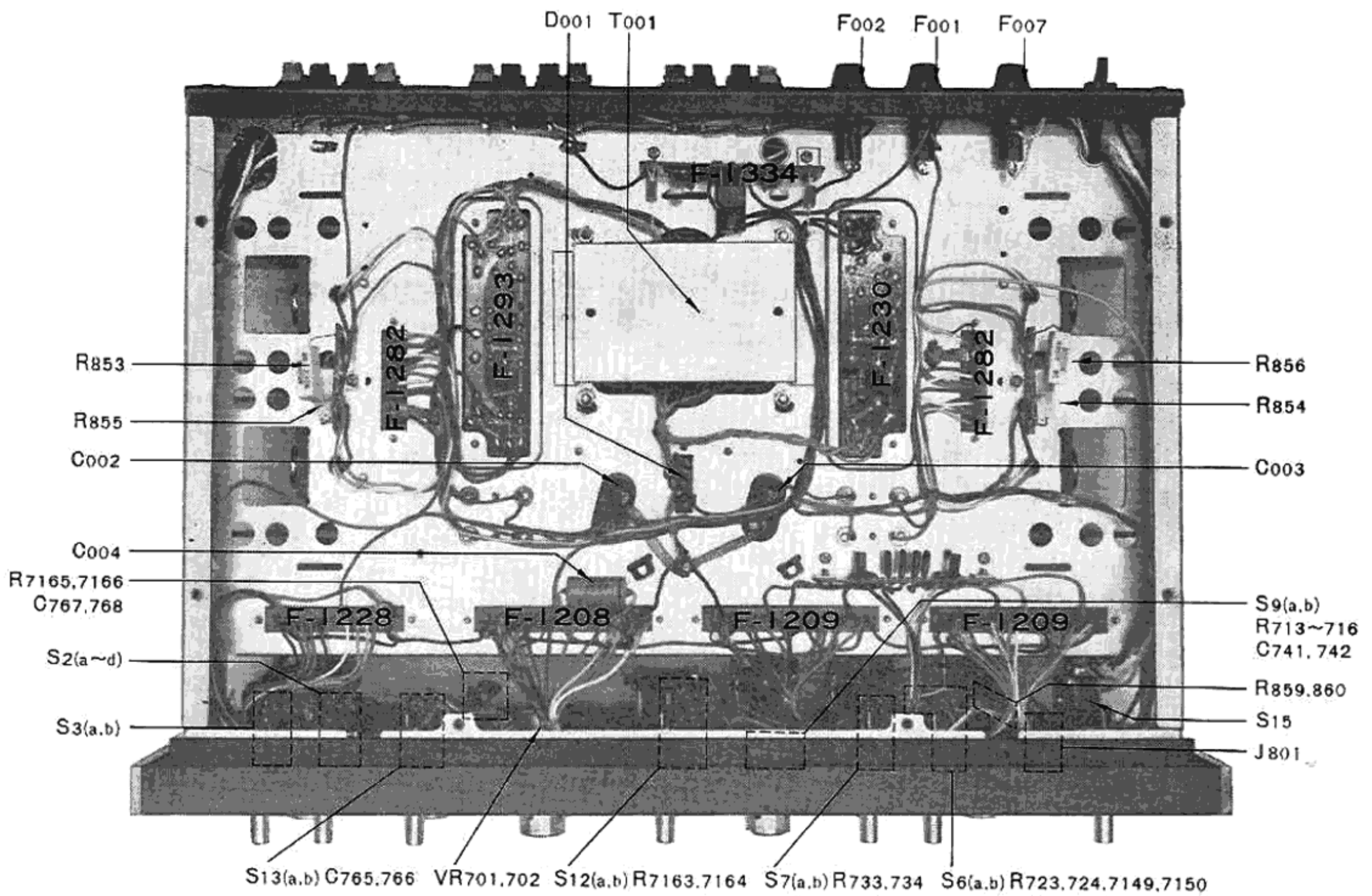

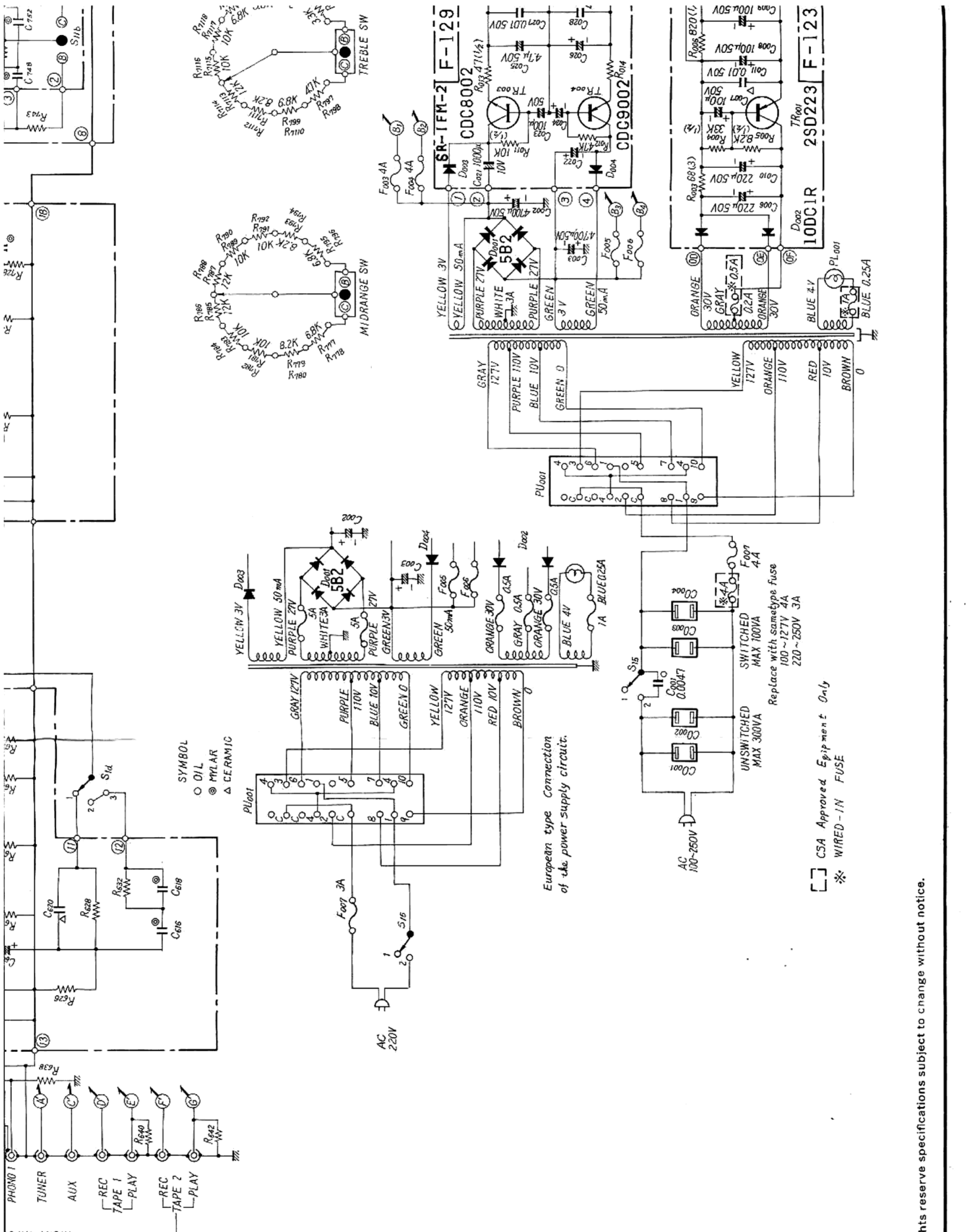

\* All rights reserved specifications subject to change without notice.

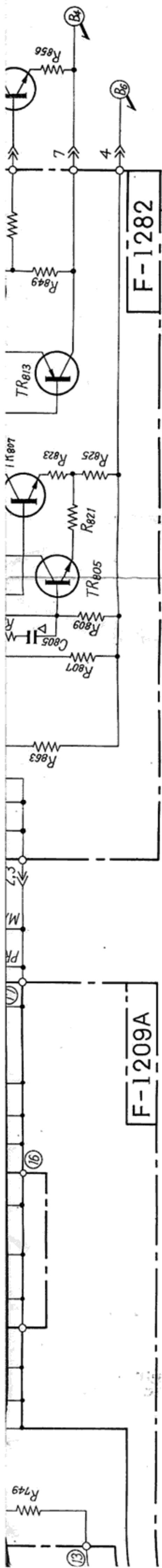

- S<sub>1</sub> (a-f) SOURCE SELECTOR 1 SW
  - 1 MIC
  - 2 PHONO 2
  - 3 PHONO 1
  - 4 TUNER
  - 5 AUX
- S<sub>2</sub> (a-d) TAPE TO TAPE REPRINT SW
  - 1 DECK 1 → 2
  - 2 SOURCE RECORD
  - 3 DECK 2 → 1
- S<sub>3</sub> (a,b) TAPE MONITOR SW
  - 1 PLAY BACK DECK 1
  - 2 SOURCE
  - 3 PLAY BACK DECK 2
- S<sub>4</sub> (a,b) PICK UP LOAD SW
  - 1 30kΩ
  - 2 50kΩ
  - 3 100kΩ
- S<sub>5</sub> (a-c) MODE SW
  - 1 STEREO REVERSE
  - 2 STEREO NORMAL
  - 3 MONO L+R
  - 4 MONO L
  - 5 MONO R
- S<sub>6</sub> (a,b) LOW FILTER SW
  - 1 OFF
  - 2 ON
- S<sub>7</sub> (a,b) HIGH FILTER SW
  - 1 OFF
  - 2 ON
- S<sub>8</sub> (a,b) MIDRANGE SW
  - 1~5 CUT
  - 6 FLAT
  - 7~11 BOOST
- S<sub>9</sub> (a,b) MIDRANGE SELECTOR SW
  - 1 1kHz
  - 2 DEFEAT
  - 3 2kHz
- S<sub>10</sub> (a,b) TREBLE SW
  - 1~4 CUT
  - 5 FLAT
  - 6~11 BOOST
- S<sub>11</sub> (a,b) BASS SW
  - 1~4 CUT
  - 5 FLAT
  - 5~11 BOOST
- S<sub>12</sub> (a,b) MUTING SW
  - 1 OFF
  - 2 -20dB
- S<sub>13</sub> (a,b) LOUNDRNESS SW
  - 1 OFF
  - 2 ON
- S<sub>14</sub> (a-h) SPEAKER SW
  - 1 SPEAKER OFF
  - 2 SYSTEM A
  - 3 SYSTEM B
  - 4 SYSTEM A+B
  - 5 SYSTEM C
- S<sub>15</sub> POWER SW
  - 1 OFF
  - 2 ON

- VR<sub>701,702</sub> BALANCE
- VR<sub>703,704</sub> VOLUME
- VR<sub>801</sub> AC BALANCE
- VR<sub>803</sub> DC BALANCE

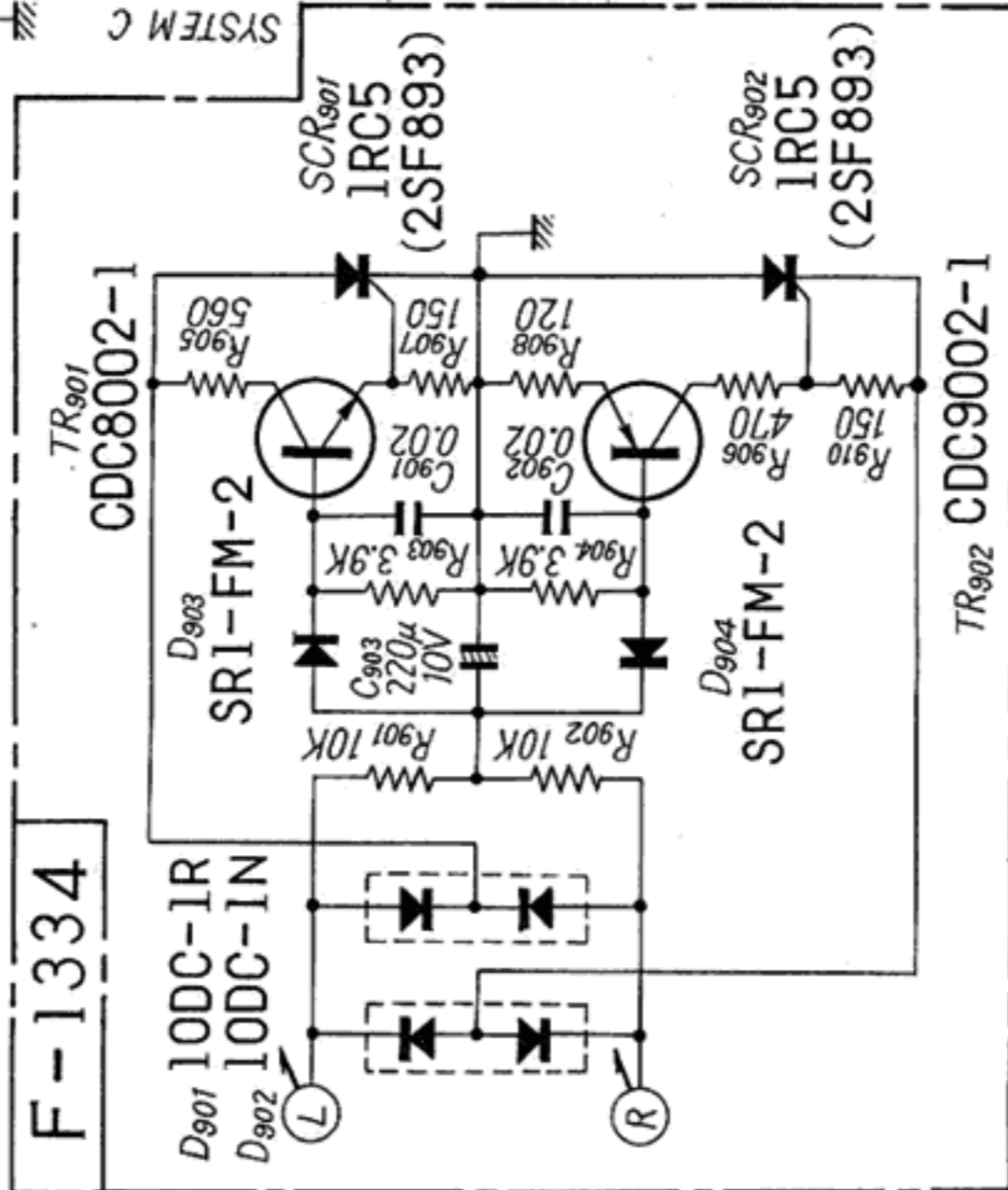
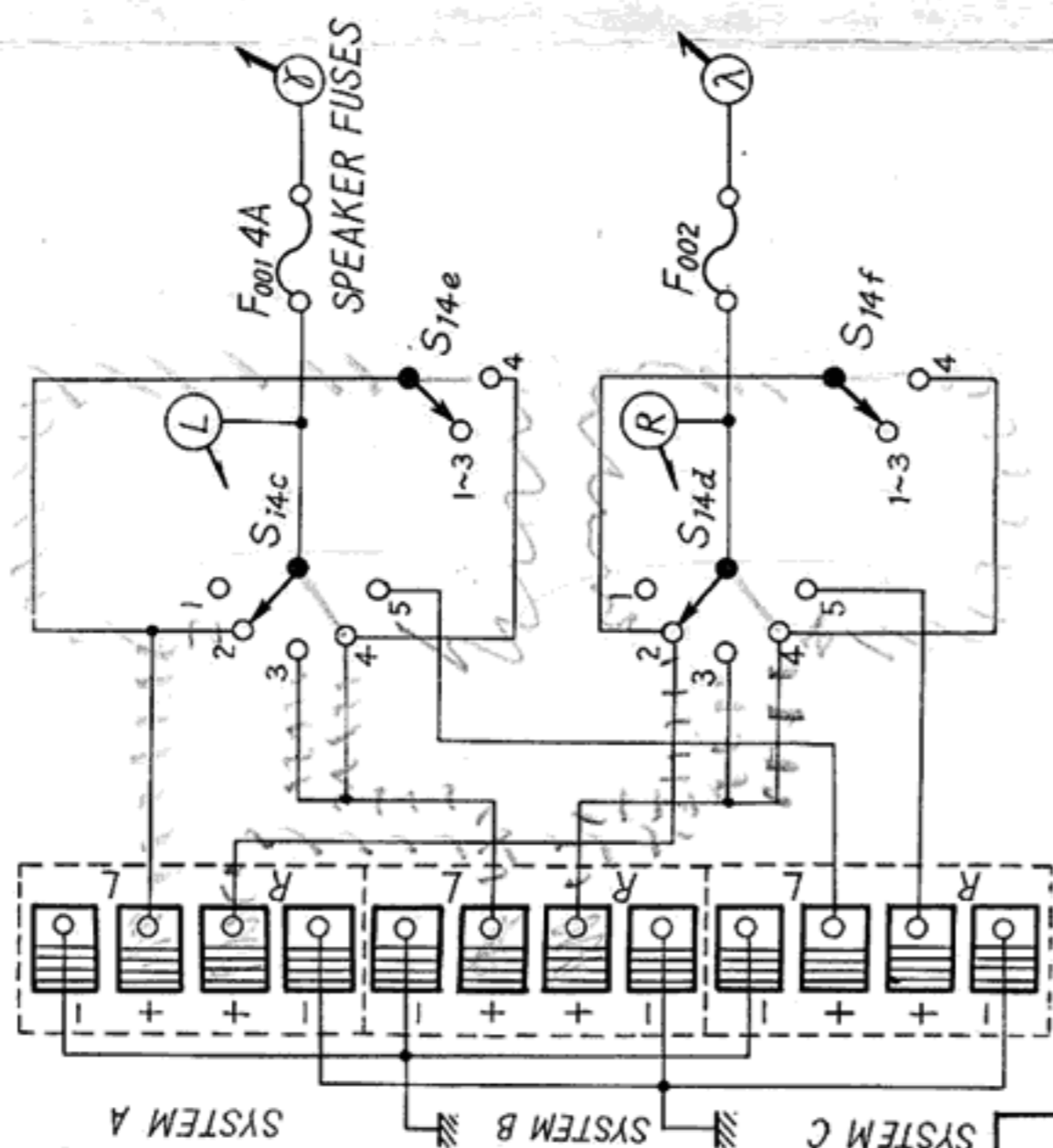

VOLTAGE ADJUSTMENT PU<sub>902</sub>

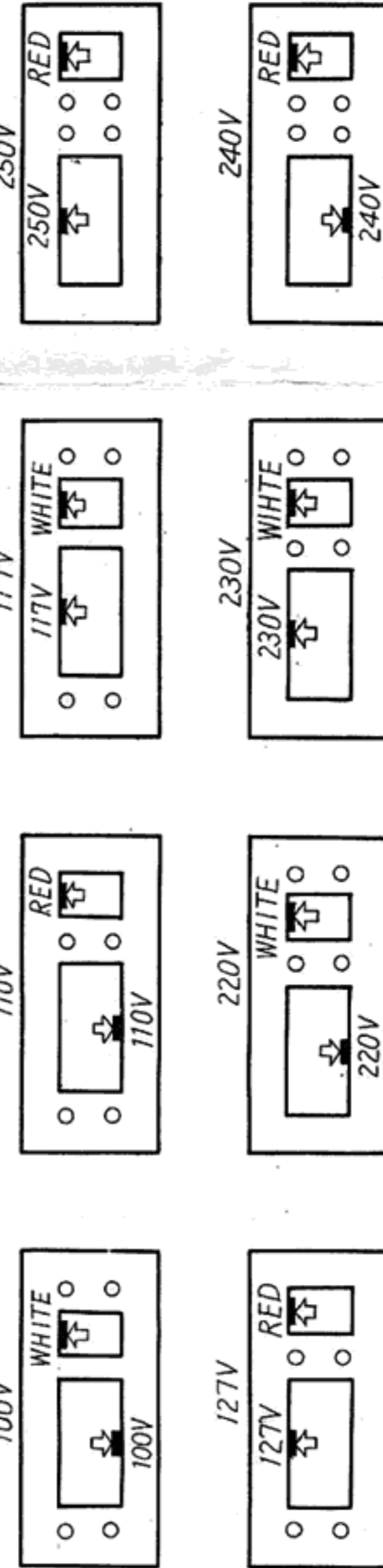

Sansui

SANSUI ELECTRIC COMPANY LIMITED

Printed in Japan (61010M4)

# HEMATIC DIAGRAM

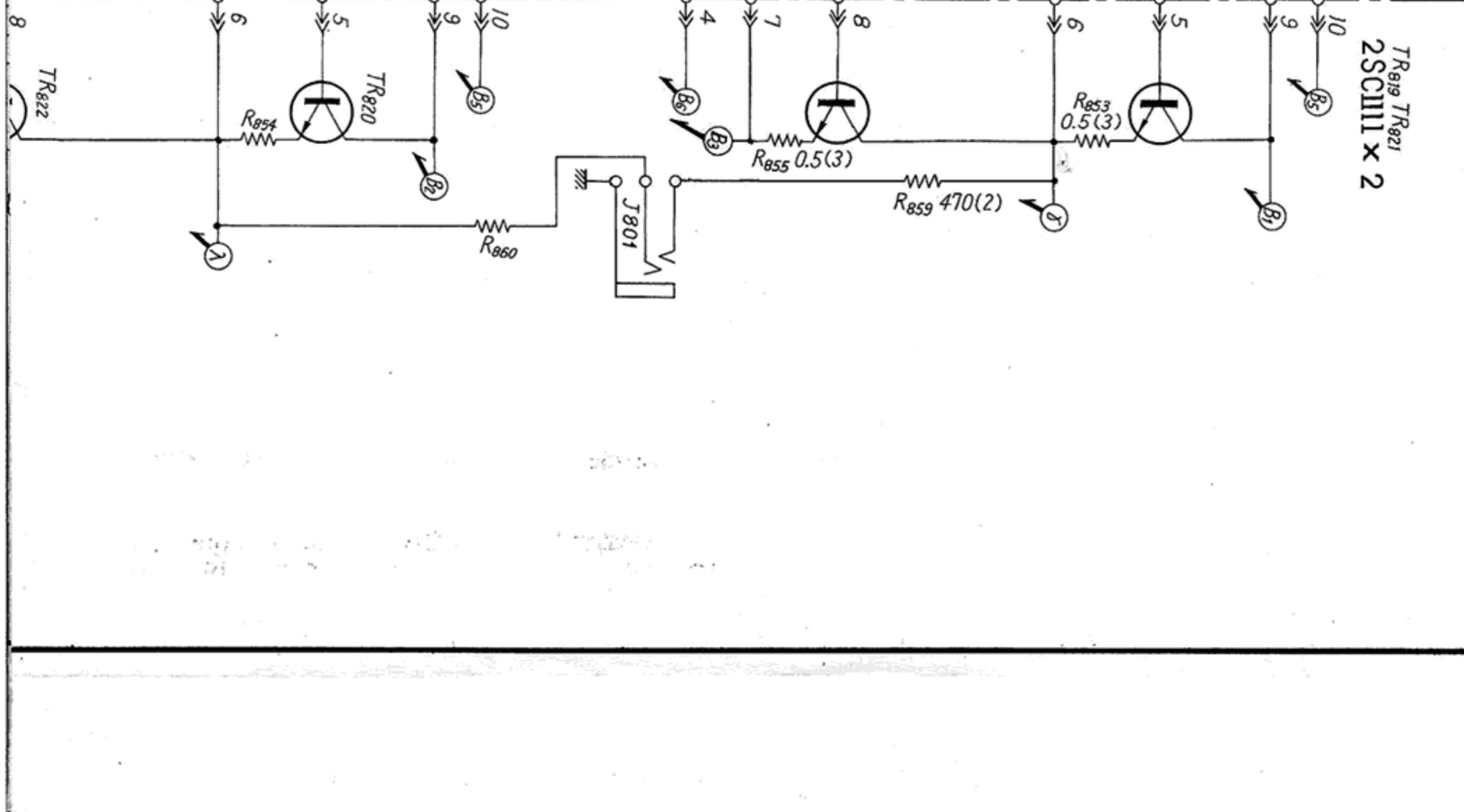
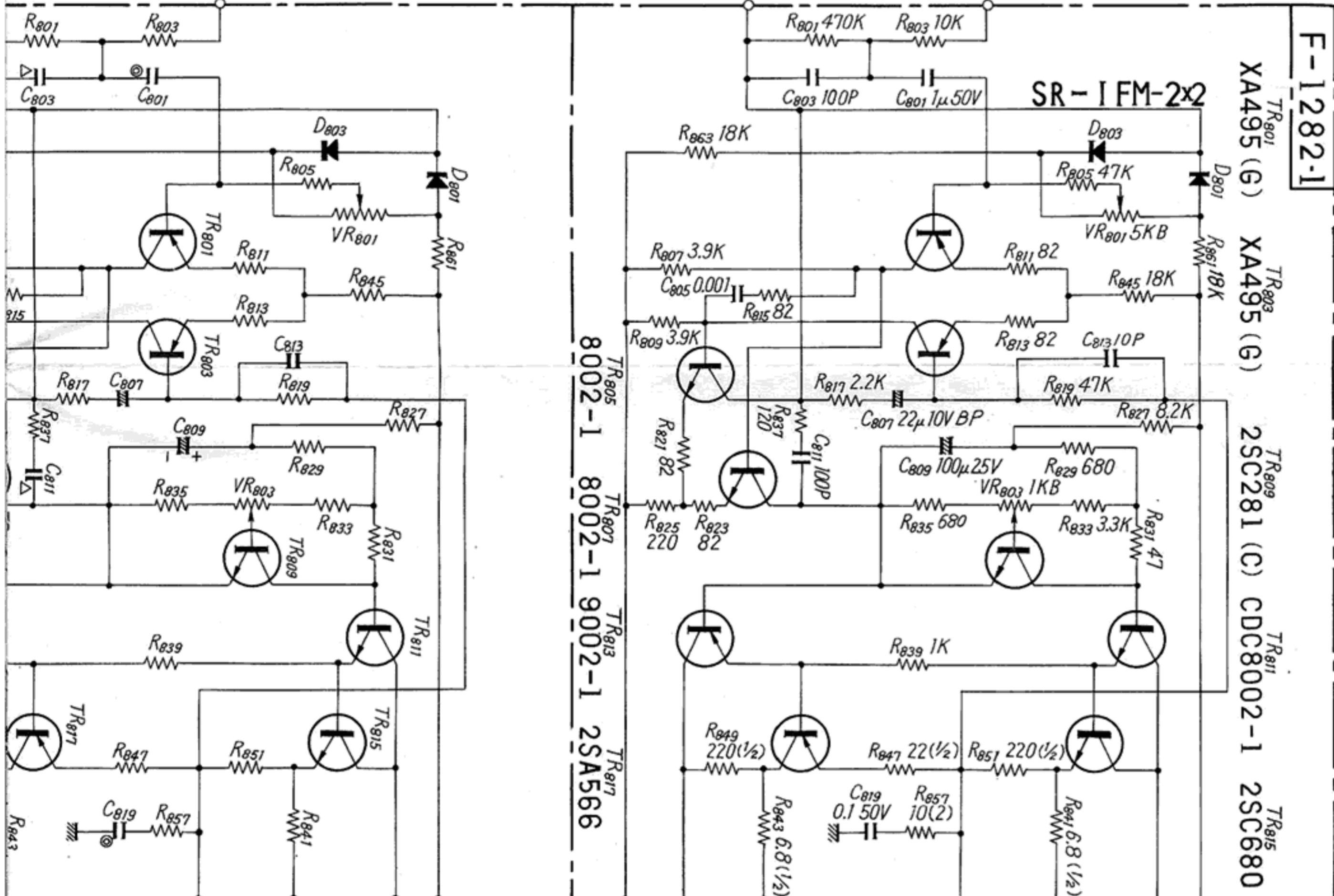
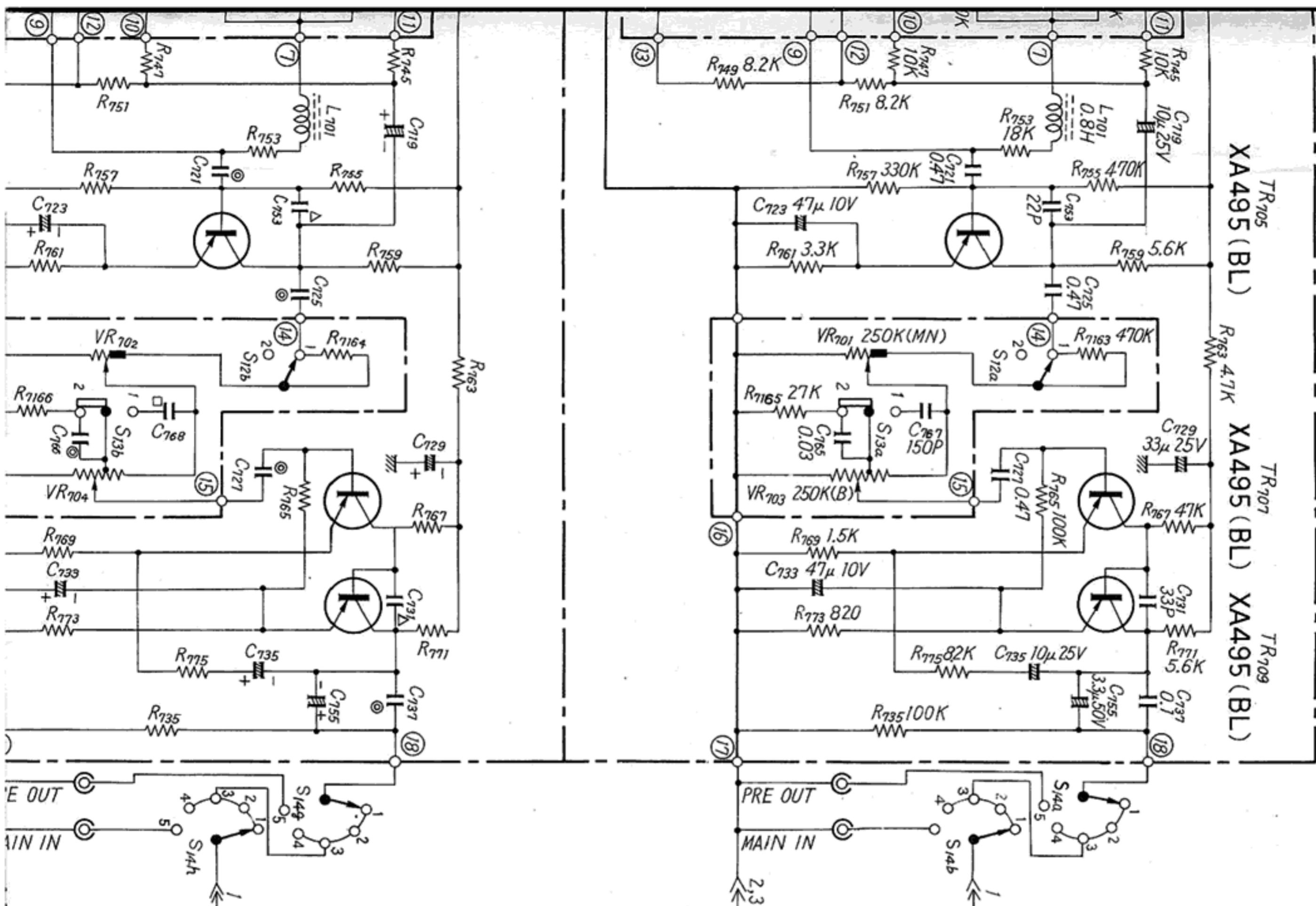

# SANSUI AU-888 SCII

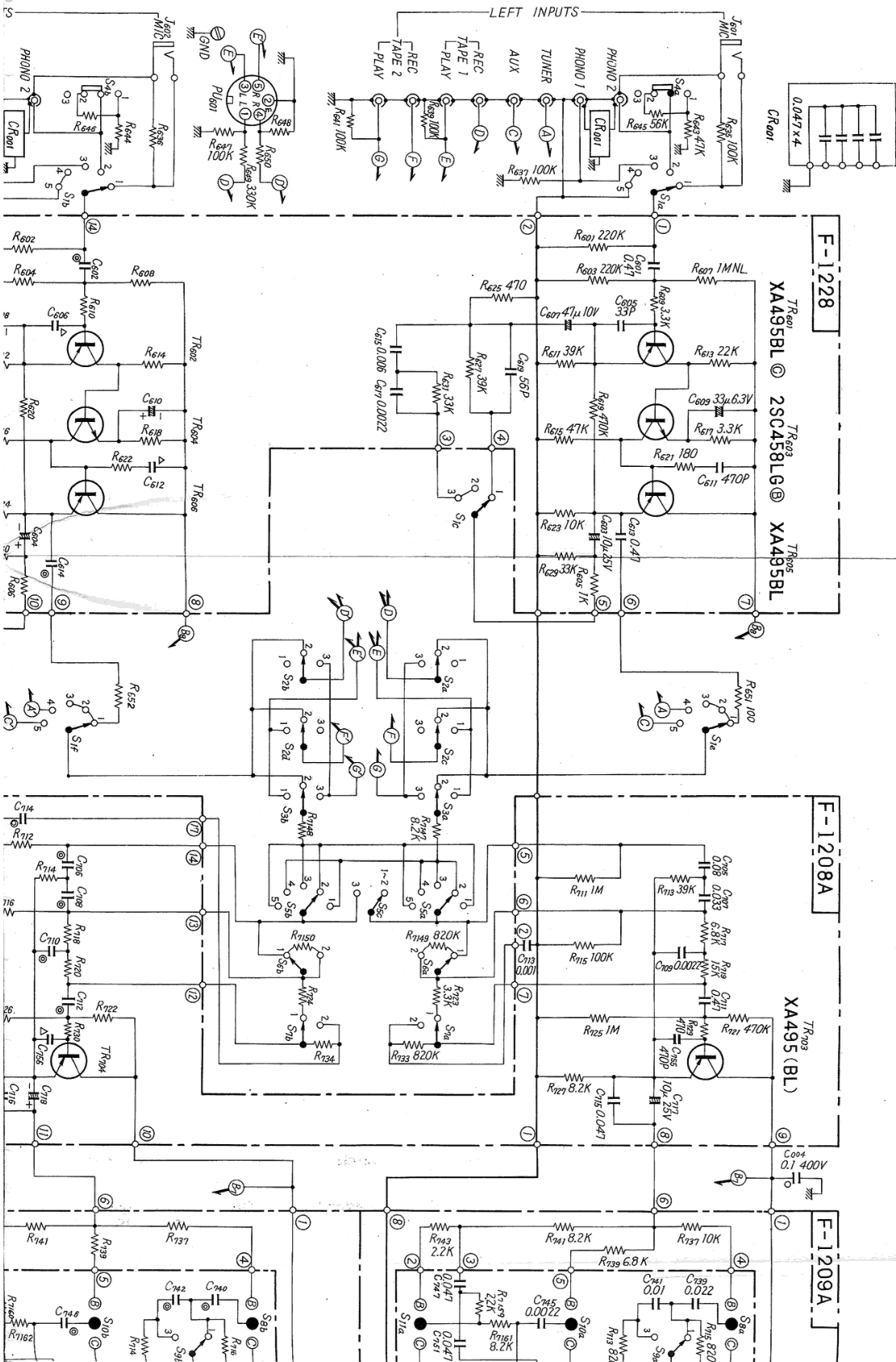

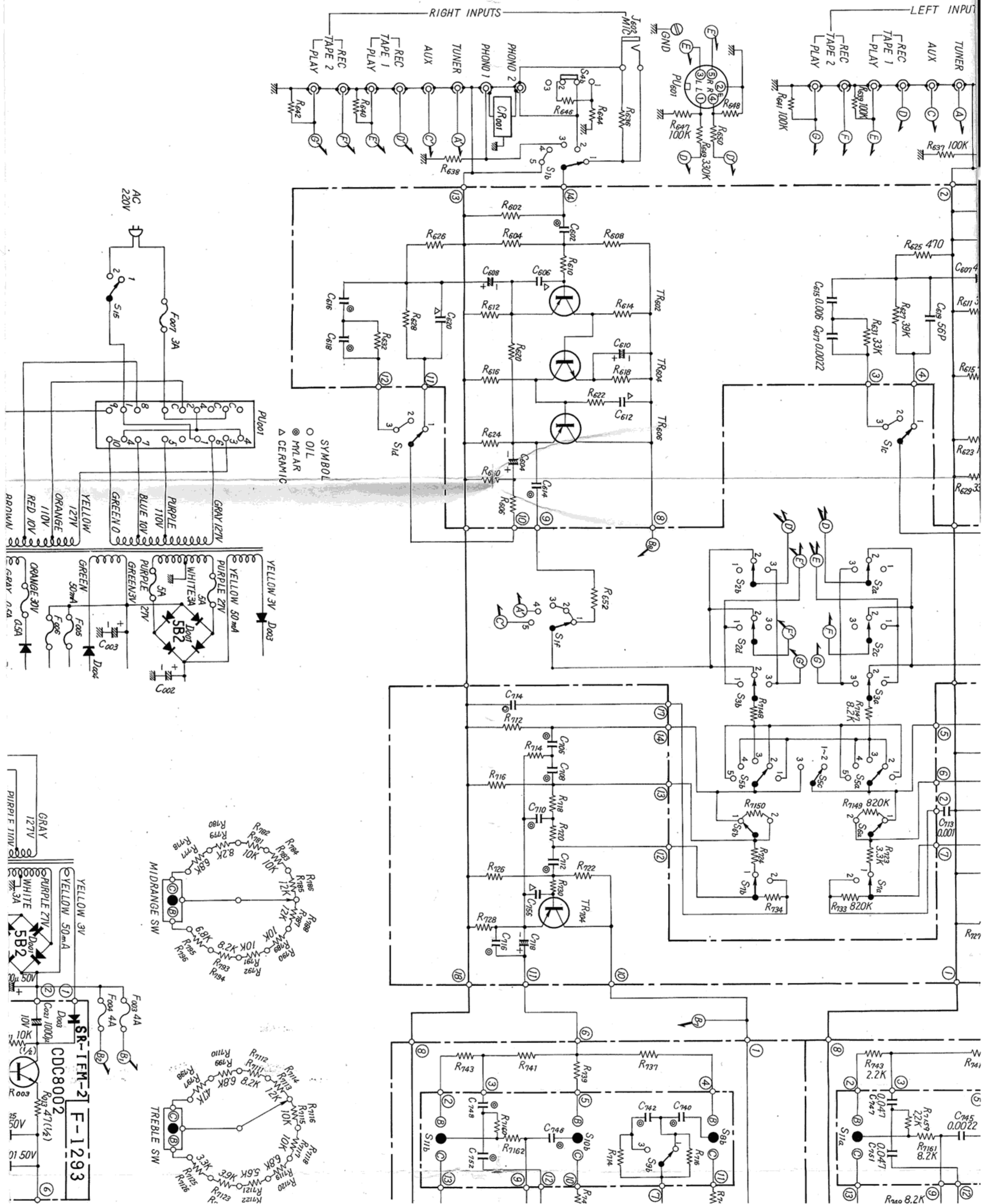



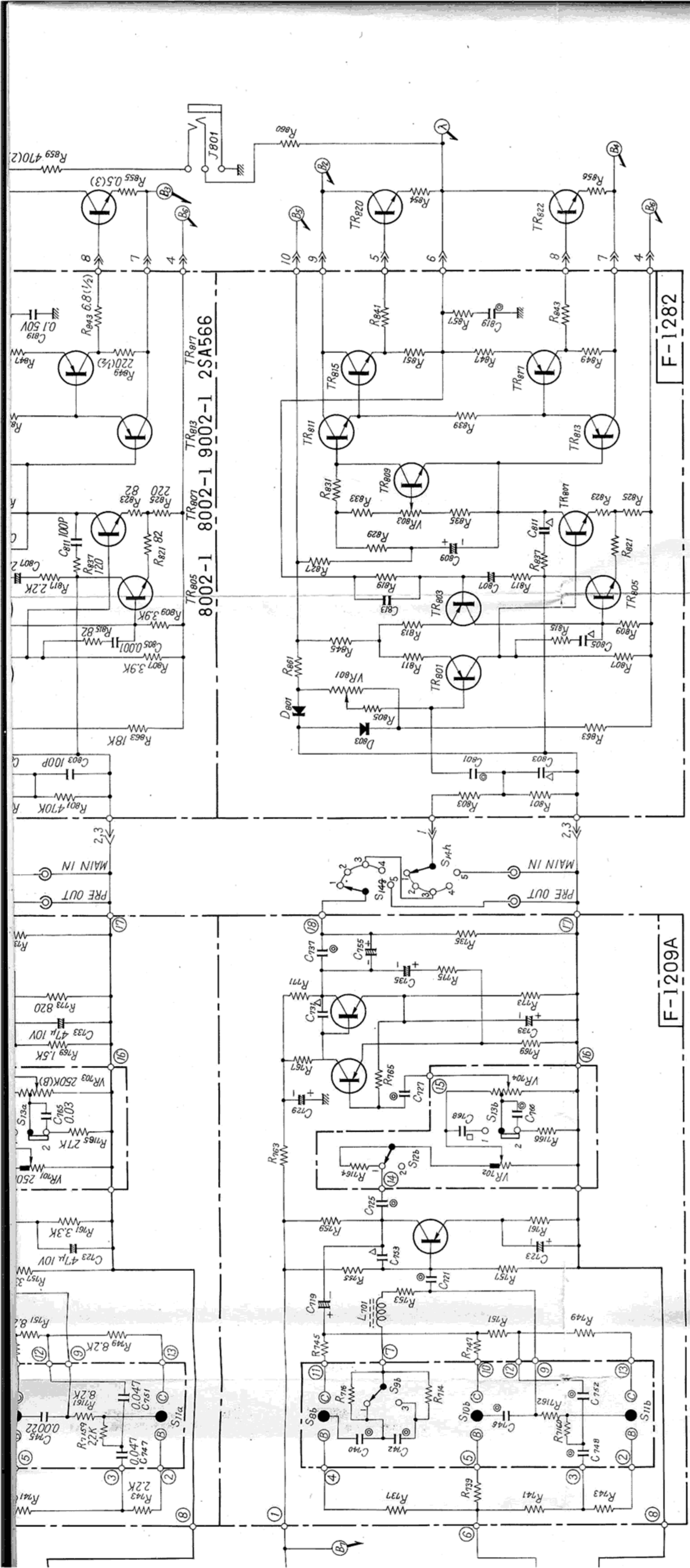

- S<sub>1</sub> (a-f) SOURCE SELECTOR 1 SW**
- 1 MIC
  - 2 PHONO 2
  - 3 PHONO 1
  - 4 TUNER
  - 5 AUX
- S<sub>2</sub> (a-d') TAPE TO TAPE REPRINT SW**
- 1 DECK 1 → 2
  - 2 SOURCE RECORD
  - 3 DECK 2 → 1
- S<sub>3</sub> (a, b) TAPE MONITOR SW**
- 1 PLAY BACK DECK 1
  - 2 SOURCE
  - 3 PLAY BACK DECK 2
- S<sub>4</sub> (a, b) PICK UP LOAD SW**
- 1 30kΩ
  - 2 50kΩ
  - 3 100kΩ
- S<sub>5</sub> (a-c) MODE SW**
- 1 STEREO REVERSE
  - 2 STEREO NORMAL
  - 3 MONO L+R
  - 4 MONO L
- S<sub>9</sub> (a, b) MIDRANGE SELECTOR SW**
- 1 1KHz
  - 2 DEFEAT
  - 3 2KHz
- S<sub>10</sub> (a, b) TREBLE SW**
- 1-4 CUT
  - 5 FLAT
  - 6-11 BOOST
- S<sub>11</sub> (a, b) BASS SW**
- 1-4 CUT
  - 5 FLAT
  - 5-11 BOOST
- S<sub>12</sub> (a, b) MUTING SW**
- 1 OFF
  - 2 -20dB
- S<sub>13</sub> (a, b) LOUDNESS SW**
- 1 OFF
  - 2 ON
- S<sub>14</sub> (a-h) SPEAKER SW**
- 1 SPEAKER OFF
  - 2 SYSTEM A
  - 3 SYSTEM B
  - 4 SYSTEM A+B

